



**EURO RETAIL
PRICE BOOK**

OCTOBER 1, 2022

TABLE OF CONTENTS

USB Digital-Audio Converters

| | |
|--------------------------------|---|
| DragonFly DACs | 5 |
| JitterBug FMJ USB Noise Filter | 5 |
| USB Extenders and Adaptors | 5 |

AC Power

| | |
|----------------------------|------|
| Power Conditioners | 7 |
| Power Cables | 9–10 |
| Power Plugs | 10 |
| Wall Outlets | 12 |
| Adaptors | 12 |
| Fog Lifters (Cable Risers) | 12 |

Speaker Cables

| | |
|----------------------------|-------|
| Q2 | 16 |
| Type Series | 16 |
| Rocket Series | 17 |
| Folk Heroes | 18–19 |
| Mythical Creatures | 20–22 |
| BiWire Jumpers | 23 |
| Fog Lifters (Cable Risers) | 23 |
| Binding Post Wrench | 23 |

Audio Interconnect Cables

| | |
|-------------------------------|----|
| Bridges & Falls | 25 |
| Rivers & Mythical Horses | 26 |
| Mythical Creatures | 27 |
| Adaptors, Splitters, Couplers | 28 |
| PreAmp Jumpers | 28 |

Subwoofer Cables

29

Tonearm & Turntable Cables

31

Vinyl Accessories

| | |
|------------------------------------|----|
| GroundGoody Tonearm & Ground Wires | 33 |
| Record Brushes | 33 |

Headphone Accessories

| | |
|---------------------------|----|
| Headshell Leads | 33 |
| NightBird Headphone Cable | 33 |
| Headphone Plug Adaptor | 33 |
| Perch Headphone Stand | 33 |

HDMI Cables

| | |
|---------------------------------------|----|
| 8K (48Gbps) | 36 |
| 4K (18Gbps) & 8K (48Gbps) Long-Length | 37 |
| 8K (48Gbps) eARC-Priority | 37 |
| Adaptors, Coupler | 38 |

Digital-Audio Interconnect Cables

| | |
|---------------------------------|-------|
| USB Cables and Adaptors | 40–41 |
| Optical Cables and Adaptor | 42 |
| Digital Coax Cables and Adaptor | 43 |
| AES/EBU (Balanced) Cables | 44 |
| Ethernet Cables (RJ/E) | 45 |

Accessories

| | |
|-------------------------------|----|
| DBS Pack | 46 |
| Q-Foot System | 46 |
| Fog Lifters (Cable Risers) | 46 |
| CleanScreen | 46 |
| Sorbothane Self-Stick Sheet | 46 |
| Binding-Post Wrench | 46 |
| Adaptors, Splitters, Couplers | 47 |
| Antenna Cables - HD6 Forest | 47 |
| RCA, XLR, Coax | |
| Plugs and Connectors | 48 |
| Noise-Stopper Caps | 49 |

Tools

| | |
|---|----|
| Crimp Tools, Cable Cutters, and Wire Strippers | 50 |
| Silver Solder | 50 |

Instant Tool-less Connectors (ITC)

| | |
|----------------|----|
| Cable Stripper | 51 |
| Bulk Cables | 51 |
| Connectors | 51 |

Bulk Speaker Cables (Spools)

| | |
|--------------------------------------|----|
| CL3/FT4 In-Wall Rated Speaker Cables | 52 |
| Speaker Cables — Not In-Wall Rated | 53 |
| SureGrip® Speaker Connectors | 54 |
| Spade, Pin, and Banana Connectors | 55 |
| Termination Pants | 55 |

Bulk Audio Interconnect Cables (Spools)

| | |
|--|----|
| CL3/FT4 In-Wall Rated Audio Interconnect Cables and Plugs | 56 |
|--|----|

Bulk Ethernet Cables (Spools)

| | |
|--|----|
| CL3/FT4 In-Wall Rated CAT6 and CAT7 Ethernet Cables & Plugs | 57 |
|--|----|

Installer Packs

| | |
|--|-------|
| Cables, Splitters and Adaptors in Single, Packs of 5 and 10 | 58–59 |
|--|-------|

POP Materials

| | |
|---------------------------------------|----|
| Wall Signs, Tent Card, Window Sticker | 60 |
| Spool Holder | 60 |
| In-Store Display Racks | 60 |

Promotional Items

| | |
|-----------------------|----|
| Polo, T-shirt, Jacket | 61 |
| Baseball Cap, Beanie | 61 |
| Pen | 61 |
| Tumbler, Water Bottle | 61 |
| License Plate Frame | 62 |
| Backpacks, Tote Bag | 62 |

Index

63–64

Terms and Conditions

- Prices are subject to change without notice.
- All prices are in Euro.
- As used throughout this price book, "Retail" carries the same meaning as Suggested Retail Price (SRP).

Returns

- All returns are subject to approval by AudioQuest.
- Built-to-order products may not be returned.
- All sales are final for custom speaker cables produced at 2m or less.
- A Return Merchandise Authorization (RMA) number must be issued by AudioQuest before any product may be returned.
- The RMA number must appear on the outside of the shipping carton, near or on the address label.

Contact Information

AudioQuest
Hoge Bergen 10
4704 RH Roosendaal
The Netherlands
www.audioquest.com
Tel: +31 165 54 1404

Email orders and related correspondence: orders@audioquest.nl

Email all other correspondence to: info@audioquest.nl

Copyright © 2022 AudioQuest.

All rights reserved.

E & OE. In the interests of continuous product improvement, all specifications are subject to change without notice.

AudioQuest: Doing No Harm Since 1980



William (Bill) Low
Founder / CEO

For 40 years now, AudioQuest, headquartered in Irvine, California, has been a leading developer, manufacturer, and distributor of high-performance audio/video products and custom-install solutions. Although best known for our comprehensive range of analog, digital, and AC power cables, our portfolio has expanded to a diverse assortment of products, including the multi-award-winning DragonFly DACs, LYRA, and Niagara and PowerQuest power products.

Our ultimate goal is the same today as it was 40 years ago: Do No Harm! By this we mean that all cables and components, to the extent that is technologically feasible, should get out of the music's way by inducing the least amount of noise and distortion.

The Evolution Continues: The Four Elements Today

While minimizing noise and damage to the audio signal remains the North-Star constant, the ways in which AudioQuest engages these challenges always evolves. While there are still Four Elements that describe our foundational materials and design philosophies, a growing number of technologies cross and even go beyond our original Four Elements. Many have become crucial enough to demand visibility. Noise-Dissipation is an umbrella Element under which many of these meaningful techniques and technologies will reside. While Geometry is no longer identified as one of The Four Elements, it remains inextricably tied to all other Elements of cable design and manufacture.

Solid Conductors: Strand interaction remains the biggest potential source of distortion in cables. Solid Conductors are the aspirational ideal and most complete solution to this problem. However, thoughtfully arranged multi-conductor geometries such as concentric windings are used to create our Semi-Solid Conductor technologies. These avoid many strand-distortion mechanisms and are in their own right ideal in a growing number of applications.

Directionality: All drawn metal conductors have a non-symmetrical, fish-scale-like grain structure. Because the highest Radio Frequencies (RF) are subject to skin effect, traveling on this deformed outer-surface layer of the conductor, there is a resulting increase in RF impedance in one direction versus the other. Since induced RF noise is parasitic (and doesn't travel with the primary signal current), it takes the path of least resistance. At AudioQuest, we test every conductor so it is used in the direction that drains the induced noise away from where it will cause the most harm, optimizing the cable and the system's performance.

Noise-Dissipation: Unwanted Radio-Frequency (RF) noise is and has always been picked up and induced into cable. This contamination ultimately masks and distorts critical portions of the audio/video signal. As this distortion-causing (parasitic) RF signal is more present today than at any previous time in history, we must depend on a wider arsenal of Noise-Dissipation technologies:

- ZERO-Tech (No Characteristic Impedance) applies Ultra-Linear Noise-Dissipation across the widest range of frequencies possible. It also enables uncompressed transient current transfer for AC power and loudspeaker/power amplifier applications.
- RF/ND-Tech (Patented Radio-Frequency Ground-Noise Dissipation) minimizes circuit misbehavior by cancelling induced RF noise.
- Tried-and-true DBS (Dielectric-Bias System) has evolved to include RF-Noise Traps that further reduce dielectric distortion and induced noise.

Metal Quality: Higher-purity conductor metals with smoother surfaces and internal crystal structures greatly reduce noise and distortion. Carefully finessed mixes of metals and conductor sizes can be effectively used to define a cable's Sonic Signature—a cost-effective technique for high-value, high-performance models.

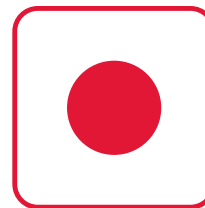

Solid Conductors

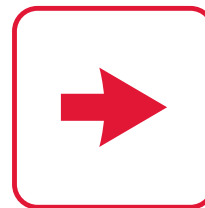

Directionality



Noise-Dissipation

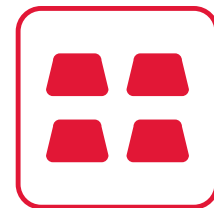

Metal Quality

DragonFly

Naturally Beautiful Sound at Your Fingertips—Whenever and Wherever You Want It

With today's smartphones, tablets, and computers, music and videos are far more accessible than ever before.

Unfortunately, the digital-to-analog converters (DACs) inside these devices are highly compromised, even when the sample-rate numbers (24/192, etc.) look impressive. These built-in DACs may make audible sound, but they don't make beautiful music.

A DragonFly bypasses the compromised audio circuitry within these devices to deliver naturally beautiful sound to earbuds, headphones, desktop speakers, or complete audio systems.

Whether using a free streaming service, premium High-Resolution or MQA-encoded streaming (such as Tidal Masters), or playing MP3 files or videos, all DragonFlies make these experiences much more compelling and immersive.

DragonFly Black delivers great performance and value. Red ups the game with more power, more grip, and deeper sonic immersion. Now, DragonFly Cobalt, with its more advanced processor, microcontroller, and RF noise filtering, provides even greater clarity, dynamics, and finesse than previously possible.



DragonFly DAC + Preamp + Headphone Amp

- Plays all music files: MP3 to High-Res and MQA
- Compatible with Apple® and Windows® PCs
- Compatible with iOS devices (requires Apple Lightning to USB 3 Camera Adaptor)
- Compatible with Android devices (requires DragonTail or other USB Adaptor for Android Devices)
- Bit-perfect variable output drives headphones, powered speakers, or power amp
- Fixed output feeds preamp or receiver



| | DragonFly Black | DragonFly Red | DragonFly Cobalt |
|------------------------------|---|--|---|
| Output | 1,2 volts | 2,1 volts | |
| DAC Chip | ESS ES9010 with minimum-phase fast roll-off filter | ESS ES9016 with minimum-phase fast roll-off filter | ESS ES9038Q2M DAC chip with minimum-phase slow roll-off filter for more natural sound |
| Volume Control | Analog Volume Control | 64-Bit Bit-Perfect Digital Volume Control | |
| Desktop Compatibility | Windows 7 and later; Apple 10.6.8 and later; Linux (no tech support provided) | | |
| Mobile Compatibility | Apple iOS 5 and later; Android 5,0 and later | | |
| Included Adaptor | | | DragonTail A to C Adaptor |
| Accessories | Protective Endcap, Leatherette Pouch | | |
| Dimensions | 62mm (l) x 19mm (w) x 12mm (h) | 62mm (l) x 19mm (w) x 12mm (h) | 57mm (l) x 19mm (w) x 12mm (h) |
| | Euro Retail: 119,00 | Euro Retail: 229,00 | Euro Retail: 329,00 |

USB Extenders and Adaptors

DragonTail USB Extenders feature 5% Silver Solid Conductors and are Direction-Controlled for reduced RF noise.



DragonTail USB A 2.0 Extender

Female USB A to Male A

Euro Retail: 29,95



DragonTail USB A to Micro Adaptor

Female USB A to Male Micro

Euro Retail: 29,95



DragonTail A to C Adaptor

(included with DragonFly Cobalt)

Euro Retail: 29,95

JitterBug FMJ USB 2.0 Noise Filter (Data & Power)

- Enables more spacious and compelling sound
- Dual Discrete Noise-Dissipation Circuits reduce all forms of internal noise in both the sending and receiving electronics
- Full Metal Jacket (FMJ) with hinged Carbon-Loaded Noise-Dissipation input cover protects against external noise
- Reduces jitter and packet errors
- Use one JitterBug in series with almost any USB DAC, including DragonFlies Black and Red; experiment with DragonFly Cobalt
- For an additional improvement, use a second JitterBug in parallel—always desirable with DragonFly Cobalt

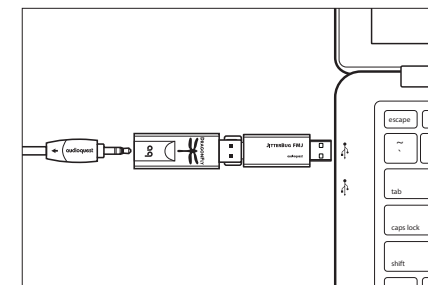

Euro Retail: 69,00

AC Power Conditioners

Niagara and PowerQuest: Low-Z Power | Noise-Dissipation Systems

Redefining the science of AC power conditioning

What is a power conditioner and why is it necessary?

For some, a power conditioner is merely a device that provides enough outlets for the entire audio/video system while also protecting the connected devices from electrical storms and wiring faults. Yet, for the discriminating listener, many power conditioners can make an audio/video system perform far worse.

Yes, a home or building may have dimming lights or an occasional brown-out, and the utilities' AC sine wave is always far from perfect. However, where incoming power is concerned, there are two reasons an audio/video system does not perform up to its full potential: 1) The current transients that supply the power amplifier are compressed, and 2) The ever-increasing levels of radio-frequency noise are masking (covering up) the system's low-level signal content.

When compared to or measured against either Niagara or PowerQuest, a simple power bar or a dedicated AC wall outlet can lose up to a third of the low-level audio information that contain much of a recording's harmonics, imaging, high frequencies, and bottom-end grip—and once that information is gone, it's gone forever.

AudioQuest's Niagara and PowerQuest technologies are unique amongst all power products—whether they're isolation transformers, AC regenerators, battery back-up, re-clocking devices, or other types. Niagara and PowerQuest filters and Ground-Noise Dissipation work evenly, or linearly, across a far wider range of induced noise frequencies. Additionally, Niagaras 3000, 5000, and 7000 feature Transient Power Correction, which supplies a current reservoir to greatly bolster the performance of any power amplifier.





| | PowerQuest 2 | PowerQuest 3 | Niagara 1200 | Niagara 3000 | Niagara 5000 | Niagara 7000 |
|---|--|---|--|--|--|--|
| Linear Noise-Dissipation Technology | More than 18 octaves of differential filtering | More than 18 octaves of differential filtering; 14 octaves common-mode filtering | Level-X More than 19 octaves of differential filtering | Level-X More than 21 octaves differential-mode filtering | Level-X More than 23 octaves differential-mode filtering; 16 octaves common-mode filtering | Level-X More than 23 octaves differential-mode filtering; 20 octaves common-mode filtering |
| Patented Ground-Noise Dissipation | 1 outlet | 2 outlets | 2 banks (all outlets) | 3 banks (all outlets) | 6 banks (all outlets) | 6 banks (all outlets) |
| Non-Sacrificial Surge Protection | Withstands multiple AC surges and spikes up to 6000V/3000A without sustaining damage | | Sonically Non-Invasive; Withstands multiple AC surges and spikes up to 6000V/3000A without sustaining damage | | | |
| Transient Power Correction | N/A | N/A | N/A | 55 amps peak; Provides a current reservoir for any power amplifier (up to 25mS) | 80 amps peak; Provides a current reservoir for any power amplifier (up to 25mS) | 80 amps peak; Provides a current reservoir for any power amplifier (up to 25mS) |
| Patented DBS Symmetrical Power Isolation Transformer | N/A | N/A | N/A | N/A | N/A | 2 (source component outlet banks) |
| Maximum RMS Current | 10 Amps (RMS) @ 220-240v | 10 Amps (RMS) @ 220-240v | 10 Amps (RMS) @ 220-240v | 10 Amps (RMS) @ 220-240v | 16 Amps (RMS) @ 220-240v | 16 Amps (RMS) @ 220-240v |
| Outlets | 6 total: (1) 4K/8K Video, (3) Source, (2) High-Current | 8 total: (2) 4K/8K Video, (4) Source, (2) High-Current | 7 total: (5) Source (including video), (2) High-Current | 7 total: (5) Source (including video), (2) High-Current | 12 total: (8) Source (including video), (4) High-Current | 12 total: (8) Source, (4) High-Current |
| USB-A Charging Ports | 2 high-speed ports (3.4 amp capacity) | 4 high-speed ports (4.8 amp capacity) | N/A | N/A | N/A | N/A |
| Power Cable | Direction-Controlled Semi-Solid Concentric - 2,1m long | | Power cable not included - For optimal results use a cable that features ZERO and GND Technology | | | |
| Signal Line Protection | N/A | Network | N/A | N/A | N/A | N/A |
| Dimensions | 393mm L x 80mm W x 153mm H (Includes wall-mounting holes and detachable base) | 393mm L x 80mm W x 188mm H (Includes wall-mounting holes and detachable base) | 493mm W x 81mm H x 190mm D | 445mm W x 88mm H x 386mm D (2-RU rack mount kit included) | 445mm W x 133mm H x 437mm D (3-RU rack mount kit on request) | 445mm W x 133mm H x 437mm D (3-RU rack mount kit on request) |
| Weight | 2,2 kg | 2,5 kg | 8,2 kg | 11,3 kg | 17,2 kg | 39 kg |
| | Euro Retail: 269,00 | Euro Retail: 399,00 | Euro Retail: 1.299,00 | Euro Retail: 3.995,00 | Euro Retail: 5.995,00 | Euro Retail: 10.995,00 |

AC Power Cables

Low-Z | Noise-Dissipation NRG, Wind, and Storm Series

The power cables that are supplied with most audio/video components have many admirable features. They're durable, flexible, small, and they will unfailingly supply the required AC voltage from the utilities' service tap for many years to come. They're also inexpensive.

Unfortunately, these "commodity" power cables were never up to the task of supplying sensitive components with the quality power they need. By this, we mean power that is unrestricted when delivering current transients to a power amplifier. The power cable must not add noise to the audio/video signal via RF (radio-frequency) noise that is induced into, or picked up by, the AV component. The ground lead is the worst offender in this regard, as it has no component power supply to help lessen the damage from the induced RF noise. Typically, the ground noise drains directly towards the component's signal path.

Even with an advanced AC power system like Niagara or PowerQuest, the AC power cable is a branch of noise-dissipation system. Like plumbing, the RF noise must be drained away from the circuits upon which it could do harm. Many ask, if my wall wiring is so many yards in length, how can a 6-foot cable possibly matter? It matters for the same reason four square inches of mud and debris can back up a plumbing system or a rain gutter. The drainage or distribution of water currents and noise currents work in the exact same manner. They are one system.

With AudioQuest AC power cables and our unique technologies such as ZERO-Tech (No Characteristic Impedance) and our patented RF/ND-Tech, you will experience greater dynamics, bass grip, extended high frequencies, and the blackest background you've ever heard.

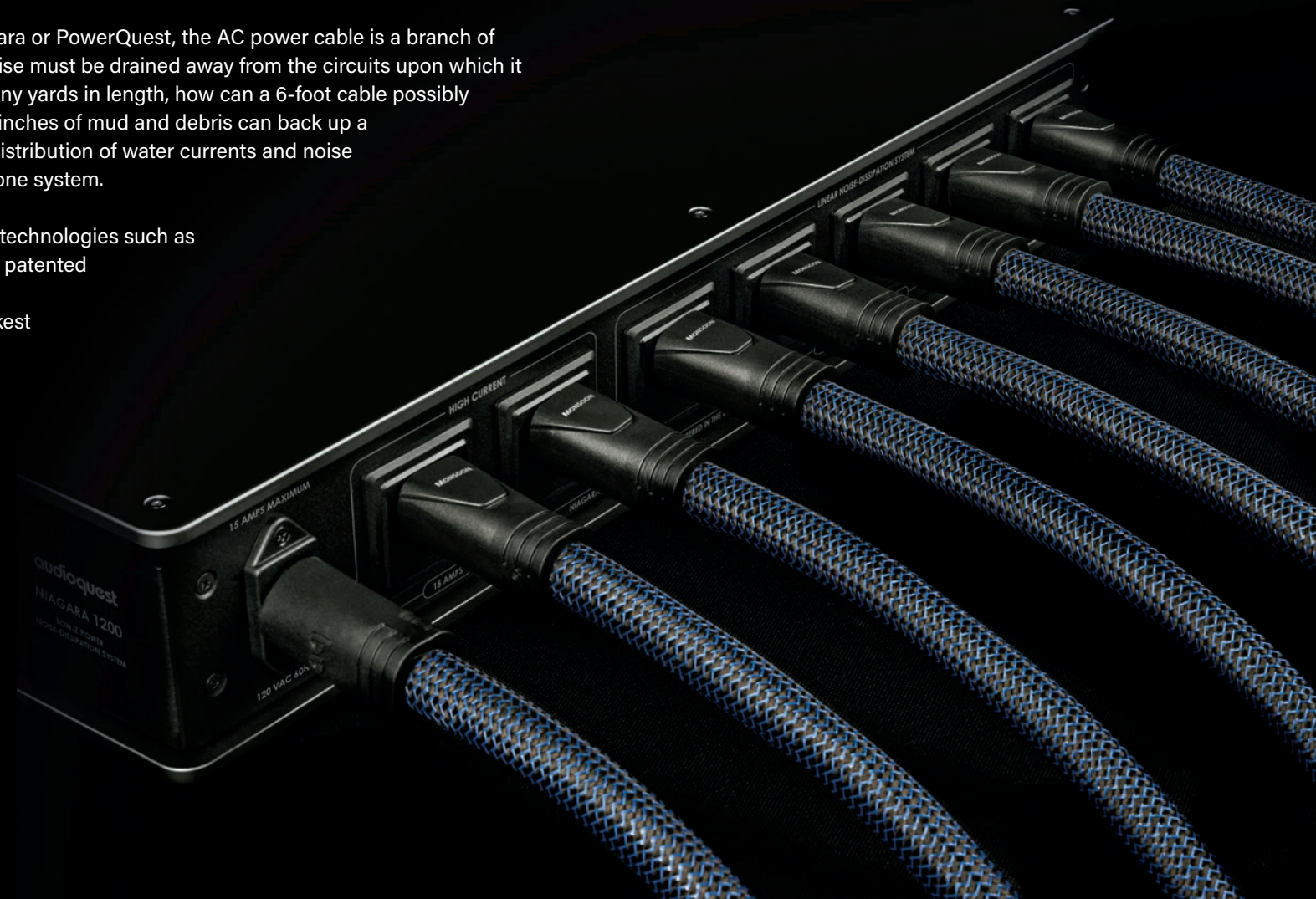

AC Power Cables: NRG Series

NRG AC cables available in Installer 5-Packs, page 58.

C5
2,5A Maximum RMS Capacity @ 230VAC 50Hz

C7
2,5A Maximum RMS Capacity @ 230VAC 50Hz



C13
15A Maximum RMS Capacity @ 230VAC 50Hz



NRG-Y2 and NRG-Z2 cables use a 2-pole C7 connector—and yet feature a 3-prong wall plug. The additional ground connection is necessary to enable ZERO-Tech, and to maximize RF-Noise Dissipation.



| Model | NRG-X2 | NRG-Y2 | NRG-Z2 | NRG-X3 | NRG-Y3 | NRG-Z3 |
|---------------------|--|--|----------------------------|---|--|--|
| Metal | Semi-Solid Concentric LGC | | Semi-Solid Concentric PSC+ | Semi-Solid Concentric LGC | | Semi-Solid Concentric PSC+ |
| Gauge | 1,04mm ² (2,5 Amp @ 220-240V) | | | 1,31mm ² (C13 Plug: 10 Amp @ 220-240v, C5 Plug: 2,5 amps @ 220-240v) | 2,08mm ² (C13 Plug: 10 Amp @ 220-240v) | 2,08mm ² (10 Amp @ 220-240v) |
| Technology | - | ZERO Tech (No Characteristic Impedance) | | - | ZERO Tech (No Characteristic Impedance) | ZERO Tech (No Characteristic Impedance); Patented RF/ND-Tech |
| Jacket | Black PVC with Red Stripes | Dark Gray/Black Braid | Dark Red/Black Braid | Black PVC with Red Stripes | Dark Gray/Black Braid | Dark Red/Black Braid |
| Terminations | Gold-Welded Connectors | | | | | |
| Length | Euro Retail | Euro Retail | Euro Retail | Euro Retail | Euro Retail | Euro Retail |
| 1m | 74,95 | 134,95 | 209,00 | 89,95 | 159,95 | 259,00 |
| 2m | 89,95 | 159,95 | 269,00 | 109,95 | 199,95 | 359,00 |
| 3m | 104,95 | 184,95 | 329,00 | 129,95 | 239,95 | 459,00 |
| 4,5m | 129,45 | - | - | 159,95 | - | - |
| 6m | 149,95 | - | - | 189,95 | - | - |



C17
For components that use the ungrounded C17 connector, please use AQ cables with a C13 connector. The grounded male plug is necessary to make use of our Noise-Dissipation System.

Note: NRG-X3 with C5 connector is available in 1m, 2m & 3m only

AC Power Cables: Wind Series

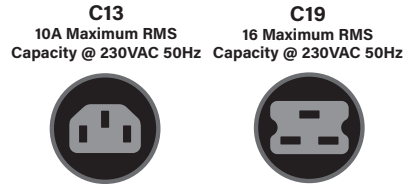

Never assume which of these is required for a component or power conditioner. Some manufacturers prefer the performance of one IEC inlet type over another—even when their circuit's current draw is minimal.



Wind Series Plugs

Wind XTRM Plugs Built From Storm-Level Components

XTRM cables have upgraded plugs equivalent in quality to the Storm Series plugs.

| Model | Monsoon | Monsoon XTRM | Blizzard ● 72v DBS | Blizzard XTRM ● 72v DBS | Silver Cloud ● 72v DBS | Silver Cloud XTRM ● 72v DBS |
|-------------------------------------|---|--|---|---|--|---|
| Plug Type | Direct-Gold Plated Molded | Hanging-Silver over Red and Beryllium Coppers | Direct-Gold Plated Molded | Hanging-Silver over Red and Beryllium Coppers | Direct-Gold Plated Molded | Hanging-Silver over Red and Beryllium Coppers |
| Metal | Semi-Solid True-Concentric Perfect-Surface Copper+ (PSC+) and Long-Grain Copper (LGC) | | Semi-Solid True-Concentric Perfect-Surface Copper+ (PSC+) | | Semi-Solid True-Concentric Perfect-Surface Silver (PSS) and Perfect-Surface Copper+ (PSC+) | |
| Gauge | 3,31mm ² | | | | | |
| Technology | ZERO-Tech (No Characteristic Impedance) for Uncompressed Current Transfer; RF/ND-Tech | | | | | |
| Jacket | Dark Blue/Black Braid  | Silver/Black Braid  | | Black/Black Braid  | | |
| Terminations | Direct-Gold and Silver Plated; Cold-Welded Connectors | | | | | |
| Length | Euro Retail | Euro Retail | Euro Retail | Euro Retail | Euro Retail | Euro Retail |
| 1m | 459,00 | 809,00 | 769,00 | 1.119,00 | 2.149,00 | 2.499,00 |
| 2m | 619,00 | 969,00 | 989,00 | 1.339,00 | 3.749,00 | 4.099,00 |
| 3m | 779,00 | 1.129,00 | 1.209,00 | 1.559,00 | 5.349,00 | 5.699,00 |
| Other prepared lengths use formula: | - | 160,00/m + 649,00 | - | 220,00/m + 899,00 | - | 1.600,00/m + 899,00 |

Mistral AC Power Bulk Cable

Metal: Semi-Solid True-Concentric Perfect-Surface Copper+ (PSC+) and Long-Grain Copper (LGC)

Gauge: 3,31mm²

Technology: RF/ND-Tech

Jacket: Dark Gray/Light Gray PVC

Terminations: Mistral AC Power Plugs

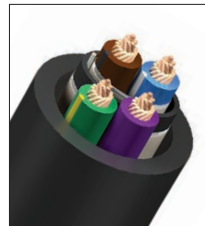

Mistral AC Power Plugs

Sold separately.



Mistral Wall Plug
Retail: 149,00



Mistral IEC C-13 Plug
Retail: 149,00



Mistral IEC C-19 Plug
Retail: 149,00

AC Power Cables: Storm Series

Never assume which of these is required for a component or power conditioner. Some manufacturers prefer the performance of one IEC inlet type over another—even when their circuit's current draw is minimal.

C13 or C15
10 Amp Maximum RMS
Capacity @ 230VAC 50Hz













C19
16 Maximum RMS
Capacity @ 230VAC 50Hz







Plugs for Storm Series

High (Variable) Current AC Power Cables - Optimized for use with AC power conditioners/regenerators, power amplifiers, and any components that contain a built-in power amplifier, including AV receivers, powered speakers, and powered subwoofers.

| Model |  Thunder ● 72v DBS |  Tornado ● 72v DBS |  Hurricane ● 72v DBS |  FireBird ● 72v DBS |  Dragon ● 72v DBS |
|--|--|--|--|---|---|
| Conductor Metal | Solid Perfect-Surface Copper+ (PSC+) plus Long-Grain Copper (LGC) | | Solid Perfect-Surface Copper+ (PSC+) | | Solid Perfect-Surface Silver (PSS) plus Solid Perfect-Surface Copper+ (PSC+) |
| RF Drain Metal | Solid 6% Silver | | | Solid Perfect-Surface Silver (PSS) | |
| Technology | ZERO-Tech (No Characteristic Impedance) for Uncompressed Current Transfer; RF/ND-Tech | | | | |
| Jacket | Brown/Black Braid  | Silver/Black Braid  | Dark Blue/Black Braid  | Dark Red/Black Braid  | Black/Black Braid  |
| Termination and Gauge | Hanging-Silver over Red and Beryllium Copper - 4,17mm ² Line and Neutral - 3,31mm ² Ground | | | | |
| Length | Euro Retail | Euro Retail | Euro Retail | Euro Retail | Euro Retail |
| 1m | 1.099,00 | 1.499,00 | 1.999,00 | 3.699,00 | 5.899,00 |
| 2m | 1.349,00 | 1.899,00 | 2.899,00 | 6.299,00 | 10.699,00 |
| 3m | 1.599,00 | 2.299,00 | 3.799,00 | 8.999,00 | 15.499,00 |
| Other prepared lengths use formula: | 250,00/m + 849,00 | 400,00/m + 1.099,00 | 900,00/m + 1.099,00 | 2.600,00/m + 1.099,00 | 4.800,00/m + 1.099,00 |

Constant-Current (Source) AC Power Cables - Optimized for use with audio/video source components, which have a constant or “fixed” current draw.

| Model | - |  Tornado ● 72v DBS |  Hurricane ● 72v DBS |  FireBird ● 72v DBS |  Dragon ● 72v DBS |
|--|---|--|--|---|---|
| Conductor Metal | - | Solid Perfect-Surface Copper+ (PSC+) | | Solid Perfect-Surface Silver (PSS) | |
| RF Drain Metal | - | Solid 6% Silver | | Solid Perfect-Surface Silver (PSS) | |
| Termination and Gauge | - | Hanging-Silver over Red and Beryllium Copper - 1,31mm ² Line, Neutral and Ground | | | |
| Length | - | Euro Retail | Euro Retail | Euro Retail | Euro Retail |
| 1m | - | 1.199,00 | 1.539,00 | 3.099,00 | 4.699,00 |
| 2m | - | 1.399,00 | 2.079,00 | 5.199,00 | 8.399,00 |
| 3m | - | 1.599,00 | 2.619,00 | 7.299,00 | 12.099,00 |
| Other prepared lengths use formula: | - | 200,00/m + 999,00 | 540,00/m + 999,00 | 2.100,00/m + 999,00 | 3.700,00/m + 999,00 |

AC Power Accessories



IEC90°/1
Adaptor Bends in
Direction of 1 Center
Retail: 22,95



IEC90°/2
Adaptor Bends in
Direction of 2 Outer Pins
Retail: 22,95

Female to Male IEC C-13 Adaptors

Premium Single-Piece Metal Conductors from Input to All Outputs Preserve Advantages of Superior AudioQuest NRG Series AC Cables.



C7 90° Adaptor Kit

- Provides 90° bends for C7 power connections
- Also connects for double bends
- Non-polarized for maximum flexibility

Package contains:

- 1 x "E" adaptor
- 1 x "U" adaptor

Retail: 45,90

C7 90° Adaptors also available in Installer 5-Packs, page 58.

Fog Lifters

Reduce the RF noise that capacitively couples into cables through all solid materials (carpet, stone, wood, etc.)



Set of 8
Retail: 159,00

Speaker Cables

Meticulously Designed to Minimize Noise and Distortion

Do No Harm: The Four Elements Today

AudioQuest's Four Elements are always applied in the most thoughtful, effective ways to offer the best performance for the money—at all price points. While our implementation of these techniques has evolved over the years, our guiding principle remains the same: *Do No Harm*.

Solid Conductors

Strand interaction remains the biggest potential source of distortion in cables. Solid Conductors are the aspirational ideal and most complete solution to this problem. However, thoughtfully arranged multi-conductor geometries such as concentric windings are used to create our Semi-Solid Conductor technologies. These avoid many strand-distortion mechanisms and are in their own right ideal in a growing number of applications.

High-Purity Metal

Higher-purity conductor metals with smoother surfaces and internal crystal structures greatly reduce noise and distortion. Carefully finessed mixes of metals and conductor sizes can be effectively used to define a cable's *Sonic Signature*—a cost-effective technique for high-value, high-performance models.

Noise-Dissipation

Unwanted Radio-Frequency (RF) noise is and has always been picked up and induced into cable. This contamination ultimately masks and distorts critical portions of the audio/video signal. As this distortion-causing (parasitic) RF signal is more present today than at any previous time in history, we must depend on a wider arsenal of Noise-Dissipation technologies:

- Directionally Controlled conductors minimize high-frequency noise by “directing” or draining it away from the most vulnerable circuits.
- ZERO-Technology (No Characteristic Impedance) applies Ultra-Linear Noise-Dissipation across the widest range of frequencies possible. It also enables uncompressed transient current transfer for AC power and loudspeaker/power amplifier applications.
- RF/ND-Tech (Patented Radio-Frequency Ground-Noise Dissipation) minimizes circuit misbehavior by cancelling induced RF noise.
- Tried-and-true DBS has evolved to include RF-Noise Traps that further reduce dielectric distortion and induced noise.

Dielectric

Insulation is necessary between conductors to minimize signal interaction and electrical shorts. The ideal is virtually no dielectric interaction (such as is achieved with our ZERO-Technology). However, by optimizing the dielectric material between signal conductors, this distortion is greatly minimized.



Speaker Cable Applications

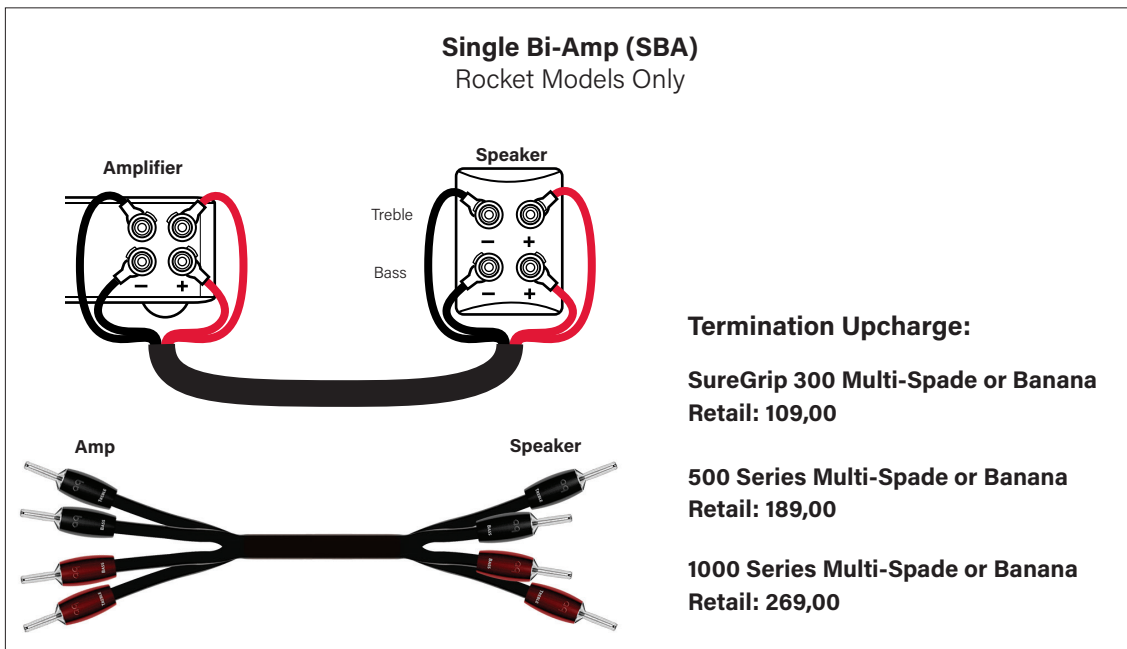
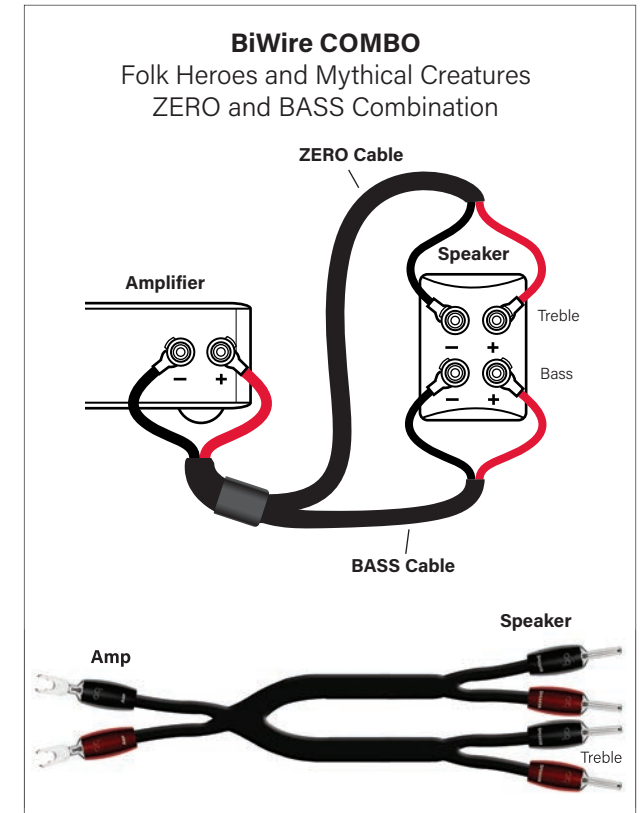
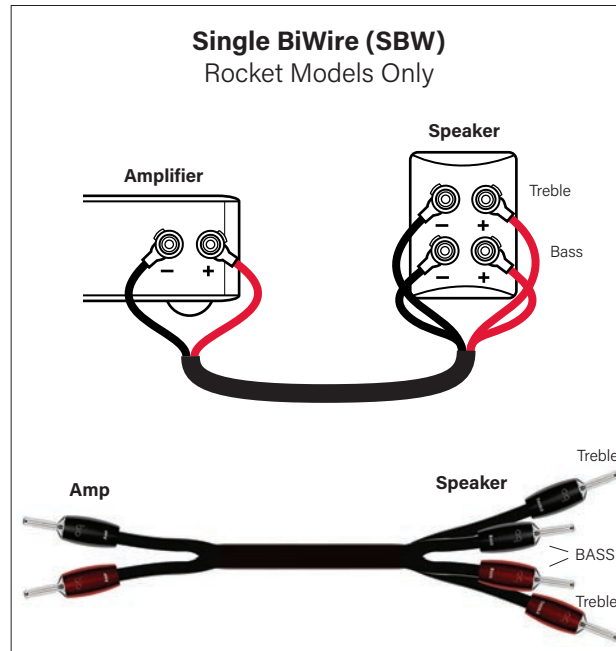
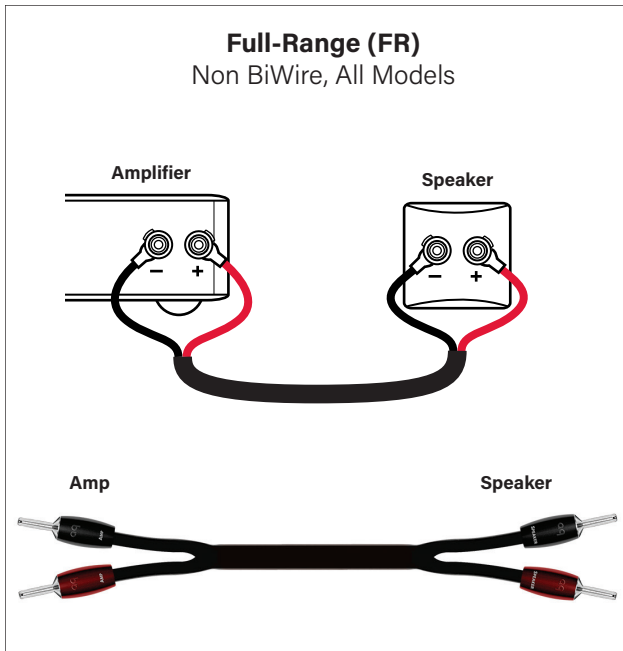

Mythical Creature & Folk Hero Termination Options: Bananas or Spades?

Amplifier-End Connector:

Choice of 1000 Series Multi-Spade, Banana, U-Spade, or V-Spade (Silver only)



Insulated (compliant) binding posts may not allow for 2 sets of connectors.

Often, the choice between terminating speaker cables with spade lugs or banana plugs will come down to personal preference. However, today's EU-compliant isolated binding posts are being used on more power amplifiers than ever before. This sometimes makes it difficult, if not impossible, to use a banana connector. Further, given the girth and weight of our Mythical Creature Series speaker cables, a spade may be better capable of fully supporting the cable. This is particularly a concern with binding posts that do not allow a banana connector to fully seat into the post.

Further, the EU-compliant posts will neither accept our V-Spade nor allow our Multi-Spade to be fully seated. For these applications (or when you're not certain), **we highly recommend the U-Spade**, as it can accommodate any binding post. The V-Spade is a specialty spade connector that works well with large wingnut binding posts (such as the Mundorf), as it allows extra clearance.

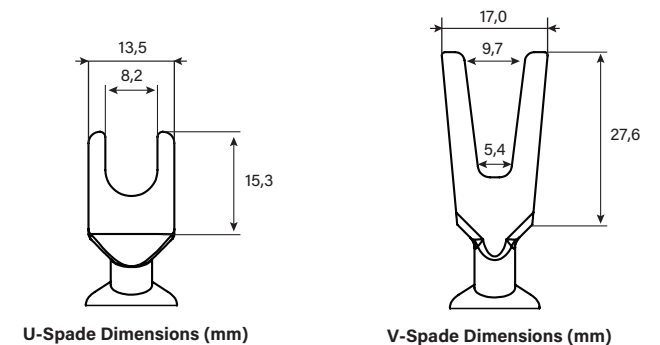
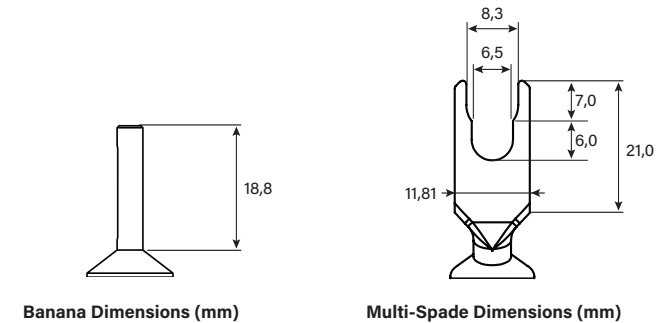

Speaker-End Connector:

Choice of 1000-Series Spade or Banana (Silver only)

Here we typically recommend the U-Spade or banana connector. However, even though there is less weight and pressure on this side of the cable (particularly for BiWire sets), it is nevertheless important to note the binding post's design. If a banana connector cannot seat all the way into the binding post, we recommend one of our spade connectors.

How to Order Prepared Speaker Cables

First please specify type of connector (banana or appropriate spade), then the finish of connector (silver*).

(*or gold where applicable)

Pair prices shown. Also available in singles (i.e. for center channel, subwoofer, or mono) at half pair price.

When ordering any factory-terminated speaker cable, please include the required elements shown in the examples below:

| Qty. | Pair or Single | Length | Model | FR/BWC/SBW | Amplifier Termination | Speaker Termination | Silver or Gold |
|------|----------------|--------|--------------|------------|-----------------------|---------------------|----------------|
| 1 | Pair | 3m | Rocket 88 | FR | Spade | Banana | Silver |
| 1 | Single | 2m | William Tell | COMBO | U-Spade | Banana | N/A |
| 1 | Single | 3m | Rocket 44 | SBW | Spade | Banana | Gold |

Speaker Cables: Q2 and Type Series (5, 9, Type 9+DBS)

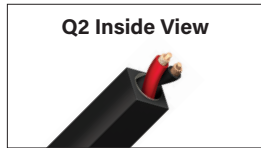

| Model | Q2 | Type 5 | Type 9 | Type 9+DBS ● 72v DBS |
|--|--|--|--|---|
| Metal | Concentric Long-Grain Copper (LGC) | Solid PSC+ Sonic-Signature Conductors and Long-Grain Copper (LGC) | Solid Perfect-Surface Copper+ (PSC+) | |
| Gauge | 1,65mm ² | 1,65mm ² | 1,65mm ² | 1,65mm ² |
| Geometry | Low-Inductance Twisted-Pair | | Star-Quad | |
| Noise-Dissipation | No | Carbon-Based Noise-Dissipation | Multi-Layer Carbon-Based Noise-Dissipation | |
| Jacket | Prepared: Black PVC Bulk: White or Black PVC | Prepared: Brown/Black Braid Bulk: Red Striped PVC | Red/Black Braid | |
| Plugs | Prepared: SureGrip 100 (Silver) Banana Bulk: SureGrip 100 (Silver or Gold) Banana | SureGrip 300 (Silver or Gold) Choice of Multi-Spade or Banana | 500 Series (Silver or Gold) Choice of Multi-Spade or Banana | 1000 Series (Silver) Choice of Multi-Spade or Banana |
| Prepared Lengths | Euro Retail | Euro Retail | Euro Retail | Euro Retail |
| 2m Pair | - | 569,00 | 789,00 | 1.239,00 |
| 2,5m Pair | - | 599,00 | 849,00 | 1.299,00 |
| 3m Pair | 329,00 | 629,00 | 909,00 | 1.359,00 |
| 4m Pair | - | 689,00 | 1.029,00 | 1.479,00 |
| Other prepared lengths use formula (per pair) | - | 60,00/m + 449,00 | 120,00/m + 549,00 | 120,00/m + 999,00 |
| Bulk Cables (on spools) | Euro Retail | Euro Retail | Euro Retail | Euro Retail |
| 50m | - | - | - | - |
| 100m | 16,50/m | 30,00/m | - | - |

Speaker Cables: Rocket Series

Please Specify Termination

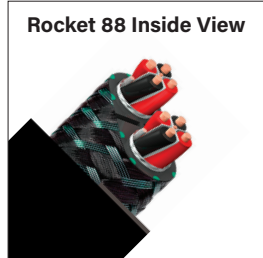

| Model | Rocket 11 | Rocket 22 | Rocket 33 | Rocket 44 | Rocket 88 ● 72v DBS |
|---|--|---|--|--|--------------------------|
| Application Options | Full-Range and Single-BiWire | Full-Range, Single-BiWire, REL and Optimized for Naim | | | |
| Metal | Semi-Solid Concentric Long-Grain Copper (LGC) | Semi-Solid Concentric PSC and LGC | Solid PSC and LGC | Solid PSC+ and PSC | Solid PSC+ |
| Gauge | 2,08mm ² | 3,31mm ² | 2,08mm ² | 3,31mm ² | |
| Geometry | Double Spiral-Pair | | Double Star-Quad | | |
| Dielectric | PVC | | Foamed-Polyethylene (For All Positive Conductors) | | |
| Noise-Dissipation | No | Carbon-Based Noise-Dissipation | | | |
| Jacket | Black PVC with Gray Stripes | Black PVC with Blue Stripes | Red/Black Braid or PVC | Silver/Black Braid or PVC | Green/Black Braid or PVC |
| Plugs | SureGrip 300 (Silver or Gold) Choice of Multi-Spade or Banana | | SureGrip 300 (Silver or Gold) Choice of Multi-Spade or Banana | 500 Series (Silver or Gold) Choice of Multi-Spade or Banana | |
| Prepared Lengths | Euro Retail | Euro Retail | Euro Retail | Euro Retail | Euro Retail |
| 2m Pair | 379,00 | 499,00 | 629,00 | 799,00 | 1.219,00 |
| 2,5m Pair | 399,00 | 549,00 | 699,00 | 899,00 | 1.349,00 |
| 3m Pair | 419,00 | 599,00 | 769,00 | 999,00 | 1.479,00 |
| 4m Pair | 459,00 | 699,00 | 909,00 | 1.199,00 | 1.739,00 |
| Other prepared lengths use formula (per pair) | 40,00/m + 299,00 | 100,00/m + 299,00 | 140,00/m + 349,00 | 200,00/m + 399,00 | 260,00/m + 699,00 |
| Bulk Cables (on spools) | Euro Retail | Euro Retail | Euro Retail | Euro Retail | Euro Retail |
| 50m | 20,00/m | 50,00/m | 70,00/m | 100,00/m | 130,00/m |
| 100m | 20,00/m | 20,00/m | 70,00/m | - | - |

Speaker Cables: Robin Hood (Folk Heroes)



| Model | Robin Hood ZERO ● 72v DBS | Robin Hood BASS ● 72v DBS | Robin Hood ZERO BiWire COMBO (ZERO + BASS) ● 72v DBS | Robin Hood SILVER ● 72v DBS | Robin Hood SILVER BiWire COMBO (SILVER + BASS) ● 72v DBS |
|--|--|--|--|---|--|
| Metal | Solid Perfect-Surface Copper+ (PSC+) | | Refer to Specs for ZERO and BASS | Solid PSS Sonic-Signature Conductors and PSC+ | Refer to Specs for SILVER and BASS |
| Gauge | 1,65mm ² | | | 1,65mm ² | |
| Geometry | ZERO-Tech (No Characteristic Impedance) | | | ZERO-Tech (No Characteristic Impedance) | |
| Noise-Dissipation | Multi-Layer Carbon-Based Noise-Dissipation | RF/ND-Tech | | Multi-Layer Carbon-Based Noise-Dissipation | |
| Jacket | Dark Green/Black Braid | Black Braid | | Light Gray/Black Braid | |
| Application Options | Full-Range, or BiWire COMBO (when combined with BASS cable) | BiWire COMBO (when combined with ZERO cable) | Full-Range, or combined with BASS to form a BiWire COMBO | | |
| Plug Options (1000 Series, Silver) | AMP-Side: Choice of U-Spade (recommended default), Banana, Multi-Spade, or V-Spade / SPEAKER-Side: Choice of U-Spade (recommended default), Banana, or Multi-Spade | | | | |
| Prepared Lengths | Euro Retail | Euro Retail | Euro Retail | Euro Retail | Euro Retail |
| 2m Pair | 1.899,00 | 1.899,00 | 3.799,00 | 6.399,00 | 8.299,00 |
| 2,5m Pair | 2.099,00 | 2.099,00 | 4.199,00 | 7.699,00 | 9.799,00 |
| 3m Pair | 2.299,00 | 2.299,00 | 4.599,00 | 8.999,00 | 11.299,00 |
| 4m Pair | 2.699,00 | 2.699,00 | 5.399,00 | 11.599,00 | 14.299,00 |
| Other prepared lengths use formula (per pair) | 400,00/m + 1.099,00 | 400,00/m + 1.099,00 | 800,00/m + 2.199,00 | 2.600,00/m + 1.199,00 | 3.000,00/m + 2.299,00 |

Speaker Cables: William Tell (Folk Heroes)



| Model | William Tell ZERO ● 72v DBS | William Tell BASS ● 72v DBS | William Tell ZERO BiWire COMBO (ZERO + BASS) ● 72v DBS | William Tell SILVER ● 72v DBS | William Tell SILVER BiWire COMBO (SILVER + BASS) ● 72v DBS |
|--|--|---|---|---|---|
| Metal | Solid Perfect-Surface Copper+ (PSC+) | Solid PSC+ Sonic-Signature Conductors and LGC | Refer to Specs for ZERO and BASS | Solid PSS Sonic-Signature Conductors and PSC+ | Refer to Specs for SILVER and BASS |
| Gauge | 2,62mm ² | | | 2,62mm ² | |
| Geometry | ZERO-Tech (No Characteristic Impedance) | | | ZERO-Tech (No Characteristic Impedance) | |
| Noise-Dissipation | Multi-Layer Carbon-Based Noise-Dissipation | RF/ND-Tech | | Multi-Layer Carbon-Based Noise-Dissipation | |
| Jacket | Dark Red/Black Braid | Black Braid | | Silver/Black Braid | |
| Application Options | Full-Range, or BiWire COMBO (when combined with BASS cable) | BiWire COMBO (when combined with ZERO cable) | Full-Range, or BiWire COMBO (when combined with BASS cable) | | |
| Plug Options (1000 Series, Silver) | AMP-Side: Choice of U-Spade (recommended default), Banana, Multi-Spade, or V-Spade / SPEAKER-Side: Choice of U-Spade (recommended default), Banana, or Multi-Spade | | | | |
| Prepared Lengths | Euro Retail | Euro Retail | Euro Retail | Euro Retail | Euro Retail |
| 2m Pair | 3.099,00 | 2.699,00 | 5.799,00 | 8.199,00 | 10.899,00 |
| 2,5m Pair | 3.499,00 | 2.999,00 | 6.499,00 | 9.849,00 | 12.849,00 |
| 3m Pair | 3.899,00 | 3.299,00 | 7.199,00 | 11.499,00 | 14.799,00 |
| 4m Pair | 4.699,00 | 3.899,00 | 8.599,00 | 14.799,00 | 18.699,00 |
| Other prepared lengths use formula (per pair) | 800,00/m + 1.499,00 | 600,00/m + 1.499,00 | 1.400,00/m + 2.999,00 | 3.300,00/m + 1.599,00 | 3.900,00/m + 3.099,00 |

Speaker Cables: ThunderBird (Mythical Creatures)



| Model | ThunderBird ZERO ● 72v DBS | ThunderBird BASS ● 72v DBS | ThunderBird ZERO BiWire COMBO (ZERO + BASS) ● 72v DBS |
|--|--|---|--|
| Metal | Solid Perfect-Surface Copper+ (PSC+) | Solid PSC+ Sonic-Signature Conductors and LGC | Refer to Specs for ZERO and BASS |
| Gauge | 5,26mm ² | | |
| Geometry | ZERO-Tech (No Characteristic Impedance) | | |
| Noise-Dissipation | Multi-Layer Carbon-Based Noise-Dissipation | RF/ND-Tech | |
| Jacket | Blue/Black Braid | | |
| Application Options | Full-Range, or BiWire COMBO (when combined with BASS cable) | BiWire COMBO (when combined with ZERO cable) | |
| Plug Options (1000 Series, Silver) | AMP-Side: Choice of U-Spade (recommended default), Banana, Multi-Spade, or V-Spade / SPEAKER-Side: Choice of U-Spade (recommended default), Banana, or Multi-Spade | | |
| Prepared Lengths | Euro Retail | Euro Retail | Euro Retail |
| 2m Pair | 5.300,00 | 4.300,00 | 9.600,00 |
| 2,5m Pair | 6.050,00 | 4.800,00 | 10.850,00 |
| 3m Pair | 6.800,00 | 5.300,00 | 12.100,00 |
| 4m Pair | 8.300,00 | 6.300,00 | 14.600,00 |
| Other prepared lengths use formula (per pair) | 1.500,00/m + 2.300,00 | 1.000,00/m + 2.300,00 | 2.500,00/m + 4.600,00 |

Speaker Cables: FireBird (Mythical Creatures)



| Model | FireBird ZERO ● 72v DBS | FireBird BASS ● 72v DBS | FireBird BiWire COMBO (ZERO + BASS) ● 72v DBS |
|--|--|--|--|
| Metal | Solid Perfect-Surface Silver (PSS) Sonic-Signature Conductors and Perfect-Surface Copper+ (PSC+) | | Refer to Specs for ZERO and BASS |
| Gauge | 10 AWG | | |
| Geometry | ZERO-Tech (No Characteristic Impedance) | | |
| Noise-Dissipation | Multi-Layer Carbon-Based Noise-Dissipation | RF/ND-Tech | |
| Jacket | Dark Red/Black Braid | | |
| Application Options | Full-Range, or BiWire COMBO (when combined with BASS cable) | BiWire COMBO (when combined with ZERO cable) | |
| Plug Options (1000 Series, Silver) | AMP-Side: Choice of U-Spade (recommended default), Banana, Multi-Spade, or V-Spade / SPEAKER-Side: Choice of U-Spade (recommended default), Banana, or Multi-Spade | | |
| Prepared Lengths | Euro Retail | Euro Retail | Euro Retail |
| 2m Pair | 15.500,00 | 11.500,00 | 27.000,00 |
| 2,5m Pair | 18.800,00 | 13.800,00 | 32.600,00 |
| 3m Pair | 22.100,00 | 16.100,00 | 38.200,00 |
| 4m Pair | 28.700,00 | 20.700,00 | 49.400,00 |
| Other prepared lengths use formula (per pair) | 6.600,00/m + 2.300,00 | 4.600,00/m + 2.300,00 | 11.200,00/m + 4.600,00 |

Speaker Cables: Dragon (Mythical Creatures)



| Model | Dragon ZERO ● 72v DBS | Dragon BASS ● 72v DBS | Dragon BiWire COMBO (ZERO + BASS) ● 72v DBS |
|--|--|--|---|
| Metal | Solid Perfect-Surface Silver (PSS) Sonic-Signature Conductors and Perfect-Surface Copper+ (PSC+) | | Refer to Specs for ZERO and BASS |
| Gauge | 10 AWG | | |
| Geometry | ZERO-Tech (No Characteristic Impedance) | | |
| Noise-Dissipation | Multi-Layer Carbon-Based Noise-Dissipation | RF/ND-Tech | |
| Jacket | Black Braid | | |
| Application Options | Full-Range, or BiWire COMBO (when combined with BASS cable) | BiWire COMBO (when combined with ZERO cable) | |
| Plug Options (1000 Series, Silver) | AMP-Side: Choice of U-Spade (recommended default), Banana, Multi-Spade, or V-Spade / SPEAKER-Side: Choice of U-Spade (recommended default), Banana, or Multi-Spade | | |
| Prepared Lengths | Euro Retail | Euro Retail | Euro Retail |
| 2m Pair | 28.700,00 | 22.100,00 | 50.800,00 |
| 2,5m Pair | 35.300,00 | 27.050,00 | 62.350,00 |
| 3m Pair | 41.900,00 | 32.000,00 | 73.900,00 |
| 4m Pair | 55.100,00 | 41.900,00 | 97.000,00 |
| Other prepared lengths use formula (per pair) | 13.200,00/m + 2.300,00 | 9.900,00/m + 2.300,00 | 23.100,00/m + 4.600,00 |

Speaker Cable Accessories

Bare Naked BiWire Jumpers

Solid PSC+ conductors offer dramatically superior performance to stamped jumpers.



Set of 4 (8.9 cm each)
Retail: 49,95

ThunderBird and Dragon BiWire Jumpers

Direction-Controlled Solid Perfect-Surface Copper+ (PSC+) Perfect-Surface Silver (PSS) and Carbon-Loaded Insulation. Available in Spade-Spade, Spade-Banana, Banana-Spade, and Banana-Banana.



ThunderBird (PSC+) uses Hanging-Silver 500 Series Bananas or Spades.

Set of 4 (20 cm each)
Retail: 349,00



Dragon (PSS) uses Hanging-Silver 1000 Series Bananas or Spades.

Set of 4 (20cm each)
Retail: 749,00

Fog Lifters

Reduce the RF noise that capacitively couples into cables through all solid materials (carpet, stone, wood, etc.)



Set of 8
Retail: 159,00

Binding-Post Wrench

Real tool-quality double-ended nut driver with metal inserts. Fits 11,1 mm and 12,7 mm binding posts.



Retail: 19,95

Using BiWire Jumpers with Full-Range Cables on BiWire Capable Speakers

3-Way or Panel-Hybrid Speaker

Please connect amp. directly to the critical midrange and tweeter Treble input, and then jumper down to the Bass input.

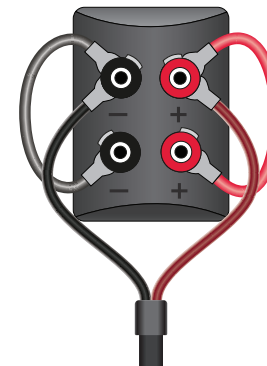

2-Way Speaker

To maintain the speaker design's delicate midrange/tweeter relationship, please connect signal to Treble (+) and Bass (-).

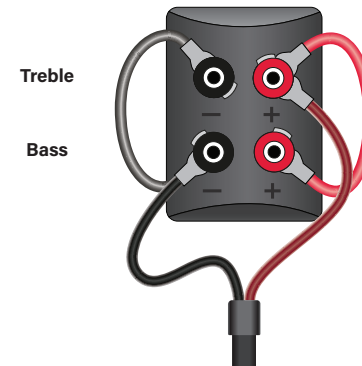

Audio Interconnect Cables

The Higher You Climb, The Less You Hear?

The evolution of AudioQuest's audio cables is a steady climb up a mountain whose summit we'll never reach — there is always room for improvement and growth, as evidenced by our new Mythical Horses and Mythical Creatures interconnects. Perhaps less intuitive is the fact that climbing up our Analog Interconnect line means you hear less of the cable.

The reason is simple: As more of the delicate audio signal is protected from damage along the way, the listener experiences more of the truth and emotional impact of the music. Greater faithfulness to the audio signal is made possible by the use of superior materials and the careful implementation of increasingly sophisticated design and construction techniques.

Music is wonderfully complex, and our ears are very sensitive to its nuances. The remarkably affordable Bridges & Falls Series is an amazing place to start the journey. For those who want better performance and can sacrifice the physical flexibility and diverse connectivity options afforded by Bridges & Falls, the Rivers and Elements are excellent choices. Every step up the ladder to the state-of-the-art Mythical Creatures Series delivers even more clarity, smoother and more natural sound, greater dynamic slam, and more nuanced expression from the music.

As you climb with your customers, you'll hear progressions in metal, from Solid Long-Grain Copper to Perfect-Surface Copper+, and PSS Silver; in Geometry, from Double- to Triple-Balanced; in insulation, from Foamed-PE to FEP Air-Tubes; and in Noise-Dissipation techniques, from Metal-Layer to Carbon-Layer to Graphene/Carbon Mesh-Network and our patented Dielectric-Bias System. And finally, in our newest "Mythical" interconnects, ZERO-Tech, which eliminates the cable's characteristic impedance for an even more "invisible" sonic signature.

Throughout the line, the AQ performance-driven value system is always 100% evident. Climb until the incremental cost of the higher model is no longer the least expensive way to make the most improvement — but don't be surprised if your customers find themselves at the top of the line before reaching that point!



Angel



Pegasus



Yosemite

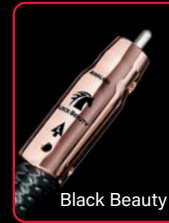

Black Beauty



Sydney



Yukon



Big Sur



Mackenzie



Golden Gate



Red River



Evergreen



Chicago



Dragon

ThunderBird

Audio Interconnect Cables: Bridges & Falls

Tower and Golden Gate also available in Installer 5-Packs, page 58.

| Model | Tower | Evergreen | Golden Gate | Big Sur | Sydney | Yosemite ● 72v DBS | Angel ● 72v DBS |
|-------------------------------------|---|--------------------|------------------------------------|---|--|---|------------------------------------|
| 3,5mm Male Mini | | | | | | | |
| 2-Male RCA | | | | | | | |
| 3,5mm Female Mini | | | | | | | |
| 5 Pin DIN | | | | | | | |
| | | | | | | | |
| Metal | Solid Long-Grain Copper (LGC) | | Solid Perfect-Surface Copper (PSC) | Solid Perfect-Surface Copper+ (PSC+) | | | Solid Perfect-Surface Silver (PSS) |
| Geometry | Asymmetrical Double-Balanced (Lower Impedance on Ground, Same Quality + and - Conductors) | | | | | | |
| Dielectric | Foamed-Polyethylene | | | | Polyethylene Air-Tubes | | FEP Air-Tubes |
| Noise-Dissipation | Metal-Layer Noise-Dissipation | | | | Carbon-Based Noise-Dissipation | | |
| Jacket | Black with White Stripes PVC | Green/Black Braid | Red/Black Braid | Brown/Black Braid | Dark Gray/Black Braid | Green/Black Braid | Silver/Black Braid |
| Termination | Cold-Welded, Gold-Plated | | | Cold-Welded, Gold-Plated Pure Purple Copper | Cold-Welded, Direct-Silver Plated Pure Purple Copper | Cold-Welded, Direct-Silver Plated Pure Red Copper | |
| Application | | | | | | | |
| 3,5mm Male Mini - 2-Male RCA | | | | Yes | | | |
| 2-Male RCA - 2-Male RCA | | | | Yes | | | |
| 3,5mm Male Mini - 3,5mm Male Mini | | | | Yes | | | |
| 3,5mm Male Mini - 3,5mm Female Mini | 3m and 5m Only | No | 2m and 5m Only | No | No | Yes | |
| 3,5mm Male Mini - 5 Pin DIN | | | | | | Yes | |
| 5 Pin DIN - 5 Pin DIN | | | | | | Yes | |
| 5 Pin DIN - 2-Male RCA | | | | | | Yes | |
| Length | Euro Retail | Euro Retail | Euro Retail | Euro Retail | Euro Retail | Euro Retail | Euro Retail |
| 0,6m | 45,95 | 79,00 | 119,00 | 159,00 | 249,00 | 469,00 | 999,00 |
| 1m | 49,95 | 89,00 | 129,00 | 169,00 | 279,00 | 519,00 | 1.199,00 |
| 1,5m | 54,95 | 99,00 | 139,00 | 185,00 | 319,00 | 579,00 | 1.449,00 |
| 2m | 59,95 | 109,00 | 149,00 | 199,00 | 359,00 | 639,00 | 1.699,00 |
| 3m | 69,95 | 119,00 | 169,00 | 229,00 | 439,00 | 759,00 | 2.199,00 |
| 5m | 89,95 | 149,00 | 219,00 | 289,00 | 599,00 | 999,00 | 3.199,00 |
| 8m | 119,95 | 209,00 | 279,00 | 379,00 | 839,00 | 1.359,00 | 4.699,00 |
| 12m | 159,95 | 279,00 | 369,00 | 499,00 | 1.159,00 | 1.839,00 | 6.699,00 |
| 16m | 199,95 | 349,00 | 459,00 | 619,00 | 1.479,00 | 2.319,00 | 8.699,00 |
| 20m | 239,95 | 419,00 | 549,00 | 739,00 | 1.799,00 | 2.799,00 | 10.699,00 |
| Other prepared lengths use formula: | - | - | - | - | - | 120,00/m + 399,00 | 500,00/m + 699,00 |

Audio Interconnect Cables: Rivers & Mythical Horses

In order to preserve ZERO-Tech's complete isolation between signal conductors, a Double-DBS pack is included for Pegasus XLR cables.



| Model | Chicago | Red River | | Mackenzie | | Yukon | | Black Beauty* | | Pegasus* | | |
|---|--|------------------------------------|----------------------------|--------------------------------------|----------------------------|-----------------------------|---|--------------------------------|-----------------------------|-------------------------------------|-------------------------------|--|
| | | RCA | XLR | RCA | XLR | RCA | XLR | RCA | XLR | RCA ● 72v DBS | XLR Double ● 72v DBS | |
| Metal | Solid Long-Grain Copper (LGC) | Solid Perfect-Surface Copper (PSC) | | Solid Perfect-Surface Copper+ (PSC+) | | | | | | | | |
| Technology | N/A | | | | | | ZERO-Tech (No Characteristic Impedance) | | | | | |
| Ground Reference | All Cables Have Separate Ground-Reference Conductors Plus One Signal Conductor for RCA and Two for XLR | | | | | | | | | | | |
| Dielectric | Hard-Cell Foamed Polyethylene | | | | Polyethylene Air-Tubes | | Hard-Cell Foamed Polyethylene | | Polypropylene Air-Tubes | | | |
| Noise-Dissipation | Metal-Layer | | | Carbon Mesh-Network | | | | ZERO-Tech + Graphene/Carbon | | 72v DBS + ZERO-Tech Graphene/Carbon | | |
| Jacket | Green/Black Braid | Red/Black Braid | | Brown/Black Braid | | Black/Dark Gray Braid | | Black/Black Braid | | Brown/Black Braid | | |
| Plug Barrels | N/A | | | | | | | | | | | |
| Cold-Welded Plugs | Gold-Plated | | | Hanging-Silver over Purple Copper | | | | Hanging-Silver over Red Copper | | | | |
| Length (Pair) | Euro Retail | Euro Retail | Euro Retail | Euro Retail | Euro Retail | Euro Retail | Euro Retail | Euro Retail | Euro Retail | Euro Retail | Euro Retail | |
| 0,5m | 129,00 | 219,00 | 279,00 | 329,00 | 399,00 | 469,00 | 549,00 | 759,00 | 919,00 | 1.499,00 | 1.799,00 | |
| 0,75m | 134,00 | 229,00 | 289,00 | 344,00 | 414,00 | 504,00 | 594,00 | 814,00 | 1.004,00 | 1.599,00 | 1.949,00 | |
| 1m | 139,00 | 239,00 | 299,00 | 359,00 | 429,00 | 539,00 | 639,00 | 869,00 | 1.089,00 | 1.699,00 | 2.099,00 | |
| 1,5m | 149,00 | 259,00 | 319,00 | 389,00 | 459,00 | 609,00 | 729,00 | 979,00 | 1.259,00 | 1.899,00 | 2.399,00 | |
| 2m | 159,00 | 279,00 | 339,00 | 419,00 | 489,00 | 679,00 | 819,00 | 1.089,00 | 1.429,00 | 2.099,00 | 2.699,00 | |
| 3m | 179,00 | 319,00 | 379,00 | 479,00 | 549,00 | 819,00 | 999,00 | 1.309,00 | 1.769,00 | 2.499,00 | 3.299,00 | |
| 4m | 199,00 | 359,00 | 419,00 | 539,00 | 609,00 | 959,00 | 1.179,00 | 1.529,00 | 2.109,00 | 2.899,00 | 3.899,00 | |
| 5m | 219,00 | 399,00 | 459,00 | 599,00 | 669,00 | 1.099,00 | 1.359,00 | 1.749,00 | 2.449,00 | 3.299,00 | 4.499,00 | |
| 6m | 239,00 | 439,00 | 499,00 | 659,00 | 729,00 | 1.239,00 | 1.539,00 | 1.969,00 | 2.789,00 | 3.699,00 | 5.099,00 | |
| 7m | 259,00 | 479,00 | 539,00 | 719,00 | 789,00 | 1.379,00 | 1.719,00 | 2.189,00 | 3.129,00 | 4.099,00 | 5.699,00 | |
| For longer lengths, please use formula: | 20,00/pair m + 119,00/pair | 40,00/pair m + 199,00/pair | 40,00/pair m + 259,00/pair | 60,00/pair m + 299,00/pair | 60,00/pair m + 369,00/pair | 140,00/pair m + 399,00/pair | 180,00/pair m + 459,00/pair | 220,00/pair m + 649,00/pair | 340,00/pair m + 749,00/pair | 400,00/pair m + 1.299,00/pair | 600,00/pair m + 1.499,00/pair | |

| Bulk Cables | Chicago | Red River | Mackenzie |
|-----------------------|--------------------|--------------------|--------------------|
| Euro Retail per metre | 10,00 (100m spool) | 20,00 (100m spool) | 30,00m (50m Spool) |

Audio Interconnect Cables: Mythical Creatures

In order to preserve ZERO-Tech's complete isolation between signal conductors, a Double-DBS pack is included for XLR cables.



| Model | ThunderBird* | | FireBird* | | Dragon* | |
|---|---|------------------------------------|------------------------------------|------------------------------------|--|------------------------------------|
| | RCA ● 72v DBS | XLR Double ● 72v DBS | RCA ● 72v DBS | XLR Double ● 72v DBS | RCA ● 72v DBS | XLR Double ● 72v DBS |
| Metal | Solid Perfect-Surface Copper+ (PSC+) | | Solid Perfect-Surface Silver (PSS) | | | |
| Technology | ZERO-Tech (No Characteristic Impedance), ZERO-Tech Cables do not work as turntable cables with moving coil cartridges | | | | | |
| Dielectric | FEP Air-Tubes | | | | | |
| Noise-Dissipation | ZERO-Tech + 72v DBS + Graphene/Carbon Mesh-Network | | | | PSS Drains + ZERO-Tech + 72v DBS + Graphene/Carbon | |
| Jacket | Blue/Black Braid | | Red/Black Braid | | Black/Black Braid | |
| Plug Barrels | Copper-Plated RF-Draining | | Silver-Plated RF-Draining | | | |
| Plug Contacts | Hanging-Silver over Red-Copper | | | | | |
| Length (Pair) | Euro Retail | Euro Retail | Euro Retail | Euro Retail | Euro Retail | Euro Retail |
| 0,5m | 2.549,00 | 3.399,00 | 4.849,00 | 5.999,00 | 7.999,00 | 9.749,00 |
| 0,75m | 2.874,00 | 3.849,00 | 5.674,00 | 7.099,00 | 9.249,00 | 11.374,00 |
| 1m | 3.199,00 | 4.299,00 | 6.499,00 | 8.199,00 | 10.499,00 | 12.999,00 |
| 1,5m | 3.849,00 | 5.199,00 | 8.149,00 | 10.399,00 | 12.999,00 | 16.249,00 |
| 2m | 4.499,00 | 6.099,00 | 9.799,00 | 12.599,00 | 15.499,00 | 19.499,00 |
| 2,5m | 5.149,00 | 6.999,00 | 11.449,00 | 14.799,00 | 17.999,00 | 22.749,00 |
| 3m | 5.799,00 | 7.899,00 | 13.099,00 | 16.999,00 | 20.499,00 | 25.999,00 |
| 4m | 7.099,00 | 9.699,00 | 16.399,00 | 21.399,00 | 25.499,00 | 32.499,00 |
| 5m | 8.399,00 | 11.499,00 | 19.699,00 | 25.799,00 | 30.499,00 | 38.999,00 |
| 6m | 9.699,00 | 13.299,00 | 22.999,00 | 30.199,00 | 35.499,00 | 45.499,00 |
| Other prepared lengths, use formula: | 1.300,00/pair m + 1.899,00/pair | 1.800,00/pair m + 2.499,00/pair | 3.300,00/pair m + 3.199,00/pair | 4.400,00/pair m + 3.799,00/pair | 5.000,00/pair m + 5.499,00/pair | 6.500,00/pair m + 6.499,00/pair |

*ZERO-Tech Cables do not work as turntable cables with moving coil cartridges.

Audio Interconnect Accessories



FLX-Mini Splitter
3,5mm Mini Male Stereo >
(2) 3,5mm Female Stereo
Metal: Solid Perfect-Surface
Copper+ (PSC+)
Length: 15cm

Euro Retail: 29,95



FLX-Mini/RCA Adaptor
3,5mm Mini Male Stereo <>
2 Female RCA (L & R)
Metal: Solid Perfect-Surface
Copper+ (PSC+)
Length: 15cm

Euro Retail: 29,95



Hard Mini/RCA Adaptor
Hard Mini 3,5mm Male <>
2 Female RCA (L & R)

Euro Retail: 19,95



FLX-X RCA Splitter
RCA Male >
2 Female RCA (L & R)
Metal: Solid Long-Grain
Copper (LGC)
Length: 15cm

Euro Retail: 26,95



FLX-X RCA Splitter
RCA Female >
2 Male (L & R)
Metal: Solid Long-Grain
Copper (LGC)
Length: 15cm

Euro Retail: 26,95



M21F-90 Adaptor
Female RCA to Right Angle
Male RCA

Euro Retail: 12,95



Hard RCA Splitter
Male RCA > 2 Female RCA

Euro Retail: 24,95



RCA - RCA Coupler
Female RCA <> Female RCA

Euro Retail: 13,95



PreAmp Jumpers
Solid Perfect-Surface Copper+ (PSC+) conductors in Polyethylene Air-Tubes. Replaces factory fitted "U" jumpers on integrated amps and receivers.

Euro Retail: 54,95

Subwoofer Cables



| Model | Black Lab | Greyhound | Irish Red | Boxer | Husky | |
|--|--|--|--|--|--|--------------------|
| | | | | | RCA ● 72v DBS | XLR ● 72v DBS |
| Metal | Solid Long-Grain Copper (LGC) | 0,5% Silver | Solid 0,5% Silver | Solid 1,25% Silver | Solid 5% Silver | |
| Geometry | Symmetrical Coax | HyperLitz Coax | Symmetrical Coax | Double-Balanced | Triple-Balanced | |
| Dielectric | Foamed-Polyethylene | | | Polyethylene Air-Tubes | | |
| Noise-Dissipation | Metal-Layer Noise-Dissipation | | | Carbon-Based Noise-Dissipation | Carbon-Based Multi-Layer Noise-Dissipation | |
| Jacket | Black with White Stripes CL3/FT4 Rated PVC | Light Gray-Striped White CL3/FT4 Rated PVC | Up to 5m: Red/Black Braid 8m and Longer CL3/FT4 Rated: Black PVC with Red Stripes | Up to 5m: Brown/Black Braid 8m and Longer CL3/FT4 Rated: Black PVC with Brown Stripes | Blue/Black Braid or CL3/FT4 Rated Black PVC with Blue Stripes (Any Length) | |
| Termination | Cold-Welded, Gold-Plated | | | Cold-Welded, Hanging-Silver directly over pure Red Copper | | |
| Application - Attached Chassis-Ground Connector | | | | | | |
| RCA - RCA | Yes | | | | | |
| RCA/XLR Mixed | No | | | | Yes | |
| Meters | Euro Retail | Euro Retail | Euro Retail | Euro Retail | Euro Retail | Euro Retail |
| 2m | 56,95 | 74,95 | 103,00 | 209,00 | 459,00 | 499,00 |
| 3m | 65,95 | 84,95 | 115,00 | 239,00 | 539,00 | 579,00 |
| 5m | 83,95 | 104,95 | 139,00 | 299,00 | 699,00 | 739,00 |
| 8m | 110,95 | 134,95 | 175,00 | 389,00 | 939,00 | 979,00 |
| 12m | 146,95 | 174,95 | 223,00 | 509,00 | 1.259,00 | 1.299,00 |
| 16m | 182,95 | 214,95 | 271,00 | 629,00 | 1.579,00 | 1.619,00 |
| 20m | 218,95 | 254,95 | 319,00 | 749,00 | 1.899,00 | 1.939,00 |
| Other prepared lengths use formula: | - | - | - | - | 80,00/m + 299,00 | 80,00/m + 339,00 |

Note: Greyhound is optimized for custom-installation projects that require its thin, discreet design. It does not include a chassis-ground connector.



THUNDERBIRD

audiodrop

audiodrop

Tonearm Cables



| Model | Yosemite ● 72v DBS | Angel ● 72v DBS | WEL Signature Limited Edition ● 72v DBS |
|--|--------------------------------------|------------------------------------|--|
| Metal | Solid Perfect-Surface Copper+ (PSC+) | Solid Perfect-Surface Silver (PSS) | |
| Dielectric | FEP Air-Tubes | | |
| Noise-Dissipation | Carbon-Based Noise-Dissipation | | Carbon-Based Multi-Layer Noise-Dissipation |
| Capacitance | Less than 90pF/1,5M | | |
| Jacket | Green/Black Braid | Silver/Black Braid | Gray/Black Braid |
| Length | Euro Retail | Euro Retail | Euro Retail |
| 1,2m | 549,00 | 1.299,00 | 2.499,00 |
| Other prepared lengths use formula: | 120,00/m + 405,00 | 500,00/m + 699,00 | 750,00/m + 1.599,00 |

Turntable Cables



| Model | Golden Gate | Yosemite ● 72v DBS | Angel ● 72v DBS | WEL Signature Limited Edition ● 72v DBS |
|--------------------------|------------------------------------|--------------------------------------|------------------------------------|--|
| Metal | Solid Perfect-Surface Copper (PSC) | Solid Perfect-Surface Copper+ (PSC+) | Solid Perfect-Surface Silver (PSS) | |
| Dielectric | Foamed-Polyethylene | FEP Air-Tubes | | |
| Noise-Dissipation | N/A | Carbon-Based Noise-Dissipation | | Carbon-Based Multi-Layer Noise-Dissipation |
| Capacitance | Less than 90pF/1,5M | | | |
| Jacket | Red/Black Braid | Green/Black Braid | Silver/Black Braid | Gray/Black Braid |
| Length | Euro Retail | Euro Retail | Euro Retail | Euro Retail |
| 1,2m | - | 549,00 | 1.299,00 | 2.499,00 |
| 1,5m | 139,00 | - | - | - |



2158

pure 22 carat gold

audioquest

gold paw contacts

99

Vinyl and Headphone Accessories

GroundGoody Tonearm & Ground Wires

Unlike other ground wires that act as radio-frequency antennas, ThunderBird and Dragon GroundGoodys prevent hum while efficiently dissipating radio-frequency noise. GroundGoodys use premium conductor materials that are controlled for direction and cold-welded to Direct-Silver Plated #10 size spade lugs. Further, AudioQuest's RF/ND-Tech dissipates and cancels most induced radio-frequency noise.



ThunderBird GroundGoody
Solid 6% Silver

| Length | Euro Retail |
|--------|-------------|
| 0,6m | 119,00 |
| 1m | 139,00 |
| 1,5m | 159,00 |
| 2m | 179,00 |
| 3m | 219,00 |



Dragon GroundGoody
Solid Perfect-Surface Silver

| Length | Euro Retail |
|--------|-------------|
| 0,6m | 449,00 |
| 1m | 599,00 |
| 1,5m | 799,00 |
| 2m | 999,00 |
| 3m | 1.399,00 |

Classic Anti-Static Record Brush

Highly Conductive Carbon Fibers

Euro Retail: 17,95



Super-Conductive Record Brush

1 248.000 Highly Conductive Carbon Fibers with No-Resistance Path to Finger-Grip

Euro Retail: 29,95



HL-5 Headshell Leads

Silk-wrapped Linear-Crystal Copper Litz Conductors

Set of 4

Euro Retail: 69,95

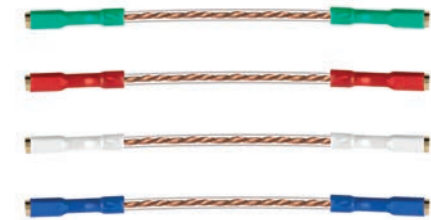

NightBird Headphone Cable

- Fits NightHawk and NightOwl Headphones
- Perfect-Surface Copper+ (PSC+)
- Noise-Dissipation
- Robust: Tested to 28,000 bends

| Length | Euro Retail |
|--------|-------------|
| 2m | 109,00 |
| 3m | 139,00 |
| 4m | 169,00 |



Headphone Plug Adaptor

- Stereo 3.5mm Female > Stereo 6,33mm (1/4") Male
- Nickel Over Extreme-Purity Brass
- Superior Materials and Firm Contact Pressure Ensure Ideal Signal Transfer

Euro Retail: 29,95



Perch Headphone Stand

- Easily and safely accommodates all headphones
- High-quality materials
- Heavy base provides stability

Euro Retail: 99,00



HDMI Cables

Does AudioQuest offer the right HDMI cables for 4K TVs, 8K TVs, and beyond?

Yes! All of AudioQuest's new 48Gbps HDMI cables can transfer up to professional 10K Ultra-HD video. The impressive 48Gbps data rate is made possible by four balanced audio/video pairs capable of 12Gbps each. And, of course, the latest technology is backwards compatible with 4K displays.

Video Up to 10K

AudioQuest 48Gbps HDMI cables are completely backwards compatible with existing devices and have the bandwidth required for video with resolutions up to 10K and resolutions/refresh rates up to 8K/60 and 4K/120.

HDR (High Dynamic Range)

All AudioQuest HDMI cables support HDR (High Dynamic Range) and Dynamic HDR. HDR content expands the contrast of the image for blacker blacks and brighter whites/highlights as well as greater color saturation and brightness. In addition, 4K Ultra-HD content allows for a wider color range.

This combination of technologies results in more realistic HDR images with greater perceived depth. Dynamic HDR (HDR10+ and Dolby Vision, for example) enables frame-by-frame HDR optimization rather than HDR settings that are fixed for the entire program. The most prominent current HDR formats are HDR10, HDR10+, and Dolby Vision.

AudioQuest 18Gbps and 48Gbps HDMI cables are compatible with all varieties of HDR, which can be found on Ultra-HD Blu-ray, and all major streaming services, including Netflix, Amazon Prime, Disney+, Apple TV+, and others.

ARC (Audio Return Channel) and eARC (enhanced Audio Return Channel)

HDMI's Audio Return Channel (ARC) sends audio from a TV to a soundbar or AV receiver for greater simplicity and flexibility in system setup. Hardware's previous ARC capabilities max out at lossy (compressed) 5.1-channel surround sound.

Today's HDMI 2.1 hardware supports enhanced Audio Return Channel (eARC), which increases the digital bandwidth dramatically to support uncompressed and lossless high-resolution multichannel audio, including Dolby TrueHD and Atmos, and DTS-HD Master Audio and DTS: X.

8K-10K



48G_{bps}

Not only do all current generations of AudioQuest HDMI cables have the conductors and bandwidth required for eARC's enhanced sonic capabilities, but, in order to ensure superior audio performance, the ARC-channel conductor-pair is internally controlled for direction, running in the opposite direction from the 4 pairs that carry information to the TV.

Finally, AudioQuest's eARC-Priority models include 4 Silver-Plated Forest 48-level audio/video data pairs—but with a far superior single data pair for the TV's audio output. By upgrading the ARC data path only, audiophile quality is made possible at a fraction of the cost of upgrading all 5 data pairs.



New Packaging

AudioQuest has turbo-charged all of its HDMI packaging with easy-to-read icons and explanations of the design and material elements that define each cable and its place in the line. Comparing, contrasting and selecting the right cable is easier than ever before.



1.25% SILVER
Solid Conductors

Solid Long-Grain Copper, Silver-Plated Copper, or Perfect-Surface Silver maximize Noise-Dissipation and overall performance.

LEVEL 3 Carbon Mesh-Network
Noise Dissipation

Six Levels of Noise-Dissipation (ND) combat distortion caused by RF Noise contaminating digital and analog circuitry.

eARC
1.25% Silver Level-3 ND

Because sound is where all the emotion and drama comes from, AQ's eARC channel gets 100% the same love as the four AV channels.

Limited
Lifetime Warranty

We've got your back. Performance backed by reliability.

48Gbps
4 x 12 = 48

The 48Gbps necessary for all of HDMI's new and future features is made possible by upgrading the 4 AV channels from 6 to 12Gbps.

HDMI: 0,75m–5m Cables

18Gbps 4K and 48Gbps 8K-10K

- All models use Solid Signal and Ground-Reference Conductors.
- All 19 conductors (A/V, eARC, Ground-Reference Drains, Control, Power) are Direction-Controlled.
- AudioQuest "48" HDMI cables have the bandwidth required for video with resolutions up to 10K, resolutions/refresh rates up to 8K/60 and 4K/120.
- For long-length models (Pearl 18, Forest 18, Root Beer 18, Cherry Cola 18, and Cherry Cola 48), see page 37.

BlueBerry 18, Pearl 48, Forest 48, and Cinnamon 48 available in Installer 5-Packs, page 59.



| Model | BlueBerry 18 | Pearl 48 | Forest 48 | Cinnamon 48 | Carbon 48 | Vodka 48 | ThunderBird 48 | FireBird 48 ● 72v DBS | Dragon 48 ● 72v DBS |
|--------------------------|--|--------------------|--------------------|----------------------------|----------------------------|----------------------------|--------------------------------------|---|------------------------|
| A/V Conductor | Solid Long-Grain Copper (LGC) | | 0,5% Silver | 1,25% Silver | 5% Silver | 10% Silver | 10% Silver | 100% PSS Silver | 100% PSS Silver |
| eARC Conductor | Solid Long-Grain Copper (LGC) | | 0,5% Silver | 1,25% Silver | 5% Silver | 10% Silver | 10% Silver | 100% PSS Silver | 100% PSS Silver |
| Ground Reference | Tinned Copper | | | 0,5% Silver | 1,25% Silver | 5% Silver | 10% Silver | 10% Silver | 100% PSS Silver |
| Noise-Dissipation | All 19 Conductors Direction-Controlled | | | Carbon + Metal + Direction | Carbon + Metal + Direction | Carbon + Metal + Direction | Graphene + Global Carbon + Direction | 72v DBS, Graphene + Global Carbon + Direction | |
| Jacket 0,6-2m | CMG (CL3/FT4) PVC | | | Red Braid | Carbon Braid | Blue Braid | Blue Braid | Red Braid | Black Braid |
| Jacket 3m | CMG (CL3/FT4) PVC | | | Red Braid or PVC | Carbon Braid | Blue Braid | Blue Braid | Red Braid | Black Braid |
| Jacket 5m | CMG (CL3/FT4) PVC | | | - | - | - | - | - | - |
| Length | Euro Retail | Euro Retail | Euro Retail | Euro Retail | Euro Retail | Euro Retail | Euro Retail | Euro Retail | Euro Retail |
| 0,6m | 29,95 | 39,95 | 69,00 | 139,00 | 179,00 | 449,00 | 759,00 | 1.599,00 | 2.299,00 |
| 1m | 34,95 | 44,95 | 79,00 | 159,00 | 199,00 | 519,00 | 899,00 | 1.799,00 | 2.699,00 |
| 1,5m | 39,95 | 49,95 | 99,00 | 179,00 | 249,00 | 599,00 | 1.049,00 | 2.049,00 | 3.199,00 |
| 2m | 44,95 | 59,95 | 119,00 | 199,00 | 299,00 | 679,00 | 1.199,00 | 2.399,00 | 3.699,00 |
| 3m | 59,95 | 79,95 | 159,00 | 269,00 | 399,00 | 839,00 | 1.499,00 | 3.199,00 | 4.699,00 |
| 5m | 99,95 | 199,95 | 299,00 | 449,00 | - | - | - | - | - |

HDMI: Long-Length Cables

18Gbps 4K and 48Gbps 8K-10K

- Pearl 18 and Forest 18 employ active frequency equalization to enable 18Gbps performance for lengths up to 15m.
- Root Beer 18 active optical cable provides 18Gbps performance for lengths up to 30m.
- Certified Ultra High Speed by HDMI Licensing, Cherry Cola 48 active optical cables provide 48Gbps performance for lengths up to 50ft.



| Model | Pearl 18 Long Distance | Forest 18 Long Distance | Root Beer 18 Optical | Cherry Cola 48 Optical |
|-------------------|--|----------------------------|--------------------------------|-----------------------------|
| A/V Conductor | LGC | 0,5% Silver | Quartz-Glass | Quartz-Glass |
| eARC Conductor | LGC | 0,5% Silver | LGC | 0,5% Silver |
| Ground Reference | Tinned Copper | | | 0,5% Silver |
| Noise-Dissipation | All 19 Conductors Direction-Controlled | | Galvanic Isolation + Direction | Carbon + Galvanic Isolation |
| Jacket | CMG (CL3/FT4) PVC | | | |
| Length | Euro Retail | Euro Retail | Euro Retail | Euro Retail |
| 5m | - | - | 469,00 | 999,00 |
| 7,5m | 239,00 | 369,00 | - | - |
| 10m | 289,00 | 459,00 | 549,00 | 1.099,00 |
| 12,5m | 359,00 | 549,00 | - | - |
| 15m | 469,00 | - | 619,00 | 1.199,00 |
| 20m | - | - | 679,00 | - |
| 25m | - | - | 739,00 | - |
| 30m | - | - | 819,00 | - |

HDMI: eARC-Priority Cables

48Gbps 8K-10K

- When using a TV's eARC/ARC output as the audio source to a soundbar or an A/V receiver or an amplifier's ARC input, eARC-Priority models offer their namesake models ARC performance for less than half the price of the namesake model. This is possible because the cables' unused A/V data pairs "only" offer better-than-Cinnamon 48 performance.



| Model | Vodka eARC Priority 48 | ThunderBird eARC Priority 48 | Dragon eARC Priority 48 72v DBS |
|-------------------|----------------------------|--------------------------------------|---|
| A/V Conductor | 0,5% Silver | 0,5% Silver | 0,5% Silver |
| eARC Conductor | 10% Silver | 10% Silver | 100% PSS Silver |
| Ground Reference | 5% Silver eARC | 10% Silver eARC | 100% PSS Silver eARC |
| Noise-Dissipation | Carbon + Metal + Direction | Graphene + Global Carbon + Direction | 72v DBS, Graphene + Global Carbon + Direction |
| Jacket 0,75-2m | Blue Braid | Blue Braid | Black Braid |
| Jacket 3.0m | CMG (CL3/FT4) PVC | | |
| Length | Euro Retail | Euro Retail | Euro Retail |
| 0,6m | 219,00 | 459,00 | 1.099,00 |
| 1m | 239,00 | 499,00 | 1.199,00 |
| 1,5m | 269,00 | 549,00 | 1.399,00 |
| 2m | 299,00 | 599,00 | 1.599,00 |
| 3m | 369,00 | 699,00 | 1.999,00 |

HDMI Accessories

Certain HDMI Adaptors available in Installer 5-Packs, page 59.

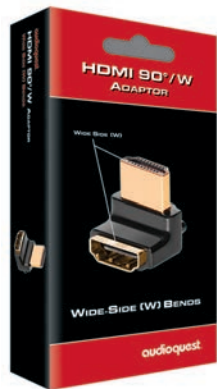

HDMI 90°/W Adaptor
Wide Side [W]
Right Angle Bend

Euro Retail: 19,95



HDMI 90°/N Adaptor
Narrow Side [N]
Right Angle Bend

Euro Retail: 19,95



HDMI 90° NU/R Flat Adaptor
Narrow Up [NU]
Bends Right

Euro Retail: 19,95

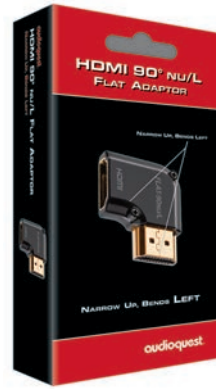

HDMI 90° NU/L Flat Adaptor
Narrow Up [NU]
Bends Left

Euro Retail: 19,95



HDMI A ↔ A Coupler
Female HDMI to Female HDMI

Euro Retail: 19,95



Mini Display Port to HDMI 4K Adaptor

Euro Retail: 39,95



DVI-IN > HDMI-OUT Adaptor

F-DVI to M-HDMI

Euro Retail: 39,95

Digital-Audio Interconnect Cables

Perfect Sound Forever?

That bold statement introduced CD players to the world back in 1983. Those claiming perfection believed ones and zeros to be so beyond reproach that traditional concerns about the integrity of the playback system had become irrelevant overnight. But the CD wasn't close to perfect. Those who listened quickly figured out that the equipment and cables in the audio system mattered every bit as much as they had in the analog era.

However, to this day, stating the truth in public that digital-audio cables can make minor to even staggering differences in an audio system's performance is like yelling, "food fight" in a crowded cafeteria—you'd better get ready to duck because there will be incoming.

Yet, the same kind of music lovers and listeners who heard the CD for what it is also know that soul-satisfying digital-audio playback requires the best digital-audio cables. And the best cables reduce the most noise and distortion.

Today, there are more ways to consume digital audio than ever. Many gave up silver discs for the convenience of inferior-sounding compressed downloads, and now we've seemingly got the best of both convenience and performance: We are able to stream high-res files to our phones and mobile devices and into our homes.

AudioQuest's digital-audio cables employ all of our proven techniques for minimizing noise and distortion: better metals, better geometry, better dielectric, Dielectric-Bias System (DBS), Noise-Dissipation, Direction-Controlled Conductors, and other ingredients needed for optimizing each specific application.

The digital future is brighter and more beautiful sounding than ever...*if* your digital-audio cables are capable of treating fragile audio data as it deserves to be treated—that is, with the love and respect reserved for music.













USB Cables

All USB A - C, USB C - B, USB C - C, Micro B, and Lightning cables are available in 0,75m and 1,5m lengths only.
For optimal sonic performance, all AudioQuest USB cables are Hi-Speed with a maximum signaling rate of 480Mbps.



| Model | Pearl | Forest | Cinnamon | Carbon | Coffee ● 72v DBS | Diamond ● 72v DBS |
|-----------------------------------|--|---|---|---|---------------------|---|
| Metal (USB A-B) | Solid Long-Grain Copper (LGC) | Solid 0,5% Silver | Solid 1,25% Silver | Solid 5% Silver | Solid 10% Silver | Solid 100% Perfect-Surface Silver (PSS) |
| Metal (All Other Versions) | Long-Grain Copper (LGC) Semi-Solid Concentric | 0,5% Silver Semi-Solid Concentric | 1,25% Silver Semi-Solid Concentric | 5% Silver Semi-Solid Concentric | N/A | Solid 100% Perfect-Surface Silver (PSS) |
| Dielectric | Hard-Cell Foam | | | | | |
| Noise-Dissipation | Metal-Layer Noise-Dissipation | | | Carbon-Based Noise-Dissipation for USB A - B and USB 3.0 A - 3.0 Micro | | |
| Jacket | Black PVC with White Stripes | Black PVC with Green Stripes | USB A-B: Red/Black Braid All others: Black PVC with Red Stripes | Gray/Black Braid | Brown/Black Braid | USB A-B: Silver/Black Braid All others: Black PVC with Silver Stripes |
| Available Configurations | USB A - B USB A - Micro B | USB A - B USB A - C USB A - Micro B 2.0 USB A - Lightning USB C - B USB C - C USB C - Lightning | USB A - B USB A - C USB A - Micro B 2.0 USB A - Lightning USB C - B USB C - C USB C - Lightning | USB A - B USB A - C USB A - Micro B 2.0 USB A - Lightning USB C - B USB C - C USB C - Lightning | USB A - B | USB A - B USB A - C USB A - Micro B 2.0 USB A - Lightning USB C - B USB C - C USB C - Lightning |
| Length | Euro Retail | Euro Retail | Euro Retail | Euro Retail | Euro Retail | Euro Retail |
| 0,75m | 39,95 | 79,00 | 109,00 | 199,00 | 439,00 | 769,00 |
| 1,5m | 49,95 | 99,00 | 139,00 | 249,00 | 529,00 | 929,00 |
| 3m | 69,95 (A-B Only) | 119,00 (A-B Only) | 179,00 (A-B Only) | 349,00 (A-B Only) | 769,00 | 1.259,00 (A-B Only) |
| 5m | 99,95 (A-B Only) | 159,00 (A-B Only) | 239,00 (A-B Only) | 499,00 (A-B Only) | 979,00 | 1.699,00 (A-B Only) |

USB Connector Applications

| | | | | |
|--|---|---|--|---|
| <p>USB A</p>   <p>For all devices that use the original USB connection.</p> | <p>USB B</p>   <p>Typically for use with computer peripherals, such as hard drives and network devices, as well as digital-audio components, including DACs and streamers.</p> | <p>USB C</p>   <p>Typically for use with newer devices, including desktops, laptops, smartphones, tablets, game consoles, hard drives, and more.</p> | <p>Micro B 2.0</p>   <p>Typically for use with compact and mobile devices, including Android smartphones and computer peripherals.</p> | <p>Lightning</p>   <p>For use with Apple devices, including iPhones and iPads.</p> |
|--|---|---|--|---|

USB Accessories



USB 3.1 Gen 2 C → A Adaptor

Euro Retail: 24,95



USB B ↔ Micro B 2.0 Adaptor

Euro Retail: 19,95



USB Mini B ↔ Micro B 2.0 Adaptor

Euro Retail: 17,95



JitterBug FMJ
USB 2.0 Noise Filter (Data & Power)

Euro Retail: 69,00



Optical Cables

Pearl, Forest, and Cinnamon available in Installer 5-Packs, page 58.



| Model | Pearl | Forest | Cinnamon | Carbon | Vodka |
|-------------------|---|---|---|---|---|
| Conductors | Low-Dispersion Fiber | Low-Dispersion High-Purity Fiber | Lower-Dispersion Highest-Purity Fiber | 19 Narrow-Aperture Highest-Purity Synthetic Fibers | 217 Narrowest-Aperture Highest-Purity Synthetic Fibers |
| Jacket | Black with Gray Stripes In-Wall Rated PVC | 0,75m and 1,5m: Green/Black Braid 3m and Longer: In-Wall Rated PVC | 0,75m and 1,5m: Red/Black Braid 3m and Longer: In-Wall Rated PVC | 0,75m to 5m: Gray/Black Braid 8m and Longer: In-Wall Rated PVC | 0,75m to 5m: Blue/Black Braid 8m and Longer: In-Wall Rated PVC |
| Length | Euro Retail | Euro Retail | Euro Retail | Euro Retail | Euro Retail |
| 0,75m | 34,95 | 54,95 | 79,00 | 139,00 | 269,00 |
| 1,5m | 39,95 | 64,95 | 99,00 | 189,00 | 349,00 |
| 3m | 59,95 | 99,95 | 149,00 | 269,00 | 549,00 |
| 5m | 79,95 | 139,95 | 199,00 | 379,00 | 749,00 |
| 8m | 109,95 | 199,95 | 299,00 | 549,00 | 1.099,00 |
| 12m | 149,95 | 279,95 | 429,00 | 749,00 | 1.499,00 |
| 16m | 189,95 | 359,95 | 549,00 | 949,00 | 1.799,00 |

Pearl available in both 3,5mm Mini to Full-Size, and Full-Size to Full-Size.
Forest, Cinnamon, Carbon, and Vodka come in Full-Size to Full-Size with 3,5mm Mini Adaptor included.

Optical Accessory



Optical Mini Adaptor

Euro Retail: 17,95

Digital Coax Cables

Forest available in Installer 5-Packs, page 59.



RCA > BNC

Recommended for Forest through Diamond.
Fully acceptable for Wild and WEL when BNC needed only on one end, or to keep an RCA/RCA cable universally useful.

Euro Retail: 19,95



| Model | Forest | Cinnamon | Carbon | Coffee | Diamond | Wild | WEL Signature |
|--|--|----------------------------|--|---|---|--|--|
| | | | | 72v DBS | 72v DBS | 72v DBS | 72v DBS |
| Metal | Solid 0,5% Silver | Solid 1,25% Silver | Solid 5% Silver | Solid 10% Silver | Solid 100% Perfect-Surface Silver (PSS) | | |
| Gauge | 24 AWG | | | 21 AWG | | | |
| Dielectric | Hard-Cell Foam | | | | | | |
| Noise-Dissipation | Metal-Layer Noise-Dissipation | | Carbon-Based Multi-Layer Noise-Dissipation | | | Carbon-Based Multi-Layer Noise-Dissipation, 2 x EMI Absorption | Carbon-Based Multi-Layer Noise-Dissipation, 3 x EMI Absorption |
| Jacket | Black PVC with Green Stripes | Red/Black Braid | Black/Dark Gray Braid | Brown/Black Braid | Silver/Black Braid | Navy Blue Braid | Black Braid |
| Terminations | Cold-Welded, Gold-Plated | | Cold-Welded, Hanging-Silver Directly Over Pure Purple Copper | Cold-Welded, Hanging-Silver Directly Over Pure Red Copper | | Cold-Welded, Hanging-Silver Directly Over Machined Pure Red Copper | |
| Shield | Foil + Tinned Braid | Foil + Silver-Plated Braid | | Silver-Plated Braid | | Copper Foil + 100% PSS-Silver Spiral | |
| Application | | | | | | | |
| RCA | Yes | | | | | | |
| BNC | No (Requires Female RCA to Male BNC adaptor) | | | | | Yes | |
| Length | Euro Retail | Euro Retail | Euro Retail | Euro Retail | Euro Retail | Euro Retail | Euro Retail |
| 0,75m | 44,95 | 89,00 | 249,00 | 649,00 | 1.219,00 | 2.500,00 | 3.900,00 |
| 1m | - | - | 269,00 | 699,00 | 1.399,00 | 2.750,00 | 4.300,00 |
| 1,5m | 54,95 | 109,00 | 309,00 | 799,00 | 1.749,00 | 3.250,00 | 5.100,00 |
| 2m | - | - | 349,00 | 899,00 | 2.099,00 | 3.750,00 | 5.900,00 |
| 3m | 74,95 | 149,00 | 429,00 | 1.099,00 | 2.799,00 | 4.750,00 | 7.500,00 |
| 5m | 99,95 | 199,00 | 589,00 | 1.499,00 | 4.199,00 | 6.750,00 | 10.700,00 |
| Other prepared lengths use formula: | - | - | 80,00/m + 189,00 | 200,00/m + 499,00 | 700,00/m + 699,00 | 1.000,00/m + 1.750,00 | 1.600,00/m + 2.700,00 |

AES/EBU (Balanced) Cables



| Model | Carbon | Diamond ● 72v DBS | Wild ● 72v DBS | WEL Signature ● 72v DBS |
|--|--|---|--|---|
| Metal | Solid 5% Silver | Solid 100% Perfect-Surface Silver (PSS) | | |
| Gauge | 24 AWG | 21 AWG | | |
| Dielectric | Hard-Cell Foam | | | |
| Noise-Dissipation | Carbon-Based Multi-Layer Noise-Dissipation | Carbon-Based Multi-Layer Noise-Dissipation, 2 x EMI Absorption | Carbon-Based Multi-Layer Noise-Dissipation, 2 x EMI Absorption | Carbon-Based Multi-Layer Noise-Dissipation, 3 x EMI Absorption |
| Jacket | Dark Gray/Black Braid | Silver/Black Braid | Navy Blue Braid | Black Braid |
| Termination | Cold-Welded, Hanging-Silver Directly Over Pure Purple Copper | Cold-Welded, Hanging-Silver Directly Over Pure Red Copper | Cold-Welded, Hanging-Silver Directly Over Machined Pure Red Copper | |
| Shield | Foil + Tinned Braid | | Foil + Silver-Plated Spiral | |
| Length | Euro Retail | Euro Retail | Euro Retail | Euro Retail |
| 0,75m | 289,00 | 1.599,00 | 2.900,00 | 4.900,00 |
| 1m | 319,00 | 1.799,00 | 3.200,00 | 5.400,00 |
| 1,5m | 379,00 | 2.199,00 | 3.800,00 | 6.400,00 |
| 2m | 439,00 | 2.599,00 | 4.400,00 | 7.400,00 |
| 3m | 559,00 | 3.399,00 | 5.600,00 | 9.400,00 |
| 5m | 799,00 | 4.999,00 | 8.000,00 | 13.400,00 |
| Other prepared lengths use formula: | 120,00/m + 199,00 | 800,00/m + 999,00 | 1.200,00/m + 2.000,00 | 2.000,00/m + 3.400,00 |

Ethernet Cables (RJ/E)

Pearl, Forest and Cinnamon available in Installer 5-Packs, page 59.



| Model | Pearl | Forest | Cinnamon | Vodka | Diamond 72v DBS |
|--------------------------|---|---|--|--|---|
| Metal | Solid Long-Grain Copper (LGC) | Solid 0,5% Silver | Solid 1,25% Silver | Solid 10% Silver | Solid 100% Perfect-Surface Silver (PSS) |
| Dielectric | Geometry Stabilizing Solid High-Density Polyethylene | | | | |
| Noise-Dissipation | Direction-Controlled Conductors | | | Carbon-Based Noise-Dissipation | |
| Jacket | CMG (CL3 & FT4) Rated Black PVC with Gray Stripes | CMG (CL3 & FT4) Rated Black PVC with Green Stripes | Up to 3,0m: Red/Black Braid 5,0m and Longer: CMG (CL3 & FT4) Rated Black PVC with Red Stripes | Up to 3,0m: Blue/Black Braid 5,0m and Longer: CMG (CL3 & FT4) Rated Black PVC with Blue Stripes | Silver/Black Braid |
| Termination | Gold-Plated Nickel Connectors with 100% Shield Coverage | | | Precision-Made Low-Loss Ultra-Wide Bandwidth Telegärtner Connectors with 100% Shield Coverage and Strain Relief | |
| Length | Euro Retail | Euro Retail | Euro Retail | Euro Retail | Euro Retail |
| 0,75m | 39,95 | 79,00 | 119,00 | 549,00 | 1.399,00 |
| 1,5m | 59,95 | 99,00 | 139,00 | 699,00 | 2.199,00 |
| 3m | 79,95 | 129,00 | 179,00 | 949,00 | 3.699,00 |
| 5m | 119,95 | 169,00 | 239,00 | 1.349,00 | 5.399,00 |
| 8m | 169,95 | 239,00 | 329,00 | 1.999,00 | 8.699,00 |
| 12m | 229,95 | 329,00 | 449,00 | 2.749,00 | 12.999,00 |

Accessories



Level-X DBS Pack 72v + Noise-Dissipation

- Niagara Custom-Built Noise-Trap Dissipates RF Noise
- 72v Dielectric-Bias System Reduces Dielectric-Noise

Euro Retail Each: 139,00



SorboGel Q-Feet System

Set of 4 energy-absorbing feet each with a "tray" which improves performance and protects furniture. Each foot supports up to 4 kg.

Euro Retail: 159,00



Fog Lifters

For use with audio and AC power cables, Fog Lifters reduce the RF noise that capacitively couples into cables through all solid materials (carpet, stone, wood, etc.)

Set of 8 Euro Retail: 159,00



Cable Clips

Fast and easy way to hold AudioQuest's largest cables in place.

AC Power Cables:

- Thunder, Tornado, Hurricane, FireBird, Dragon

Speaker Cables:

- Robin Hood, William Tell
- ThunderBird, FireBird, Dragon

Interconnect Cables (RCA and XLR):

- ThunderBird, FireBird, Dragon

Set of 6 Euro Retail: 10,00



CleanScreen Kit

150 ml. Bottle + 10 ml. Spray + Retractable Brush

Euro Retail: 29,95



Sorbothane Self-Stick Sheet

15,24cm x 15,24cm x 0,25cm sheet can be cut to size to damp anything, especially effective on top surface of speaker stands.

Euro Retail: 54,95



Binding-Post Wrench

Real tool-quality double-ended nut driver with metal inserts.

Fits 11,1 mm and 12,7mm binding posts.

Euro Retail: 19,95

Accessories



RCA \leftrightarrow BNC Adaptor
Female RCA to/from Male BNC

Euro Retail: 19,95



F > RCA Male Adaptor
Female RCA to Male RCA

Euro Retail: 12,95



F > BNC Male Adaptor
75 Ω

Euro Retail: 19,95



F > 2F Splitter
3GHz 75 Ω

Euro Retail: 19,95



F > 4F Splitter
3GHz 75 Ω

Euro Retail: 25,95



F \leftrightarrow F
75 Ω Coupler

Euro Retail: 8,95



F-90°
Male \leftrightarrow Female Adaptor

Euro Retail: 12,95

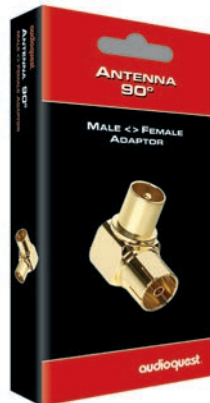

Antenna 90°
Male \leftrightarrow Female Adaptor

Euro Retail: 9,95

Antenna Cable



| Model | Antenna HD6 Forest |
|---------------------------|---|
| Conductor | Solid 0,5% Silver |
| Shield | 3-Layer Shield: Foil + 90% Braid + Foil |
| Jacket | Dark Gray with Green Stripes |
| Application | |
| Male Coax - Male Coax | Yes |
| Male Coax - Female Coax | Yes |
| Female Coax - Female Coax | Yes |
| F - F | Yes |
| Length | Euro Retail |
| 1,5m | 50,00 |
| 3m | 65,00 |
| 4,5m | 80,00 |

Accessories

RCA-300

Fits cables up to 7,0mm O.D.
Gold-Plated. Requires soldering.



#300 Male
Set of 4
Euro Retail: 60,00

#300 Female
Set of 4
Euro Retail: 60,00

RCA-800

Fits cables up to 9,0mm O.D.
Direct-Silver Plated. Requires soldering.



#800 Male
Set of 4
Euro Retail: 80,00

XLR Connectors

Fits cables up to 9,0mm O.D.
Direct-Silver Plated. Requires soldering.



#81 Male
Pair
Euro Retail: 120,00

#80 Female
Pair
Euro Retail: 120,00

Right-Angle F and RCA Plugs

Fits cables up to 7,5mm O.D.
Gold-Plated. Requires soldering.



F-90°
Pair
Euro Retail: 50,00

RCA-90°
Pair
Euro Retail: 50,00

Accessories



RJ45 Noise-Stopper Caps
 AQ Noise-Stopper Caps fit over unused RJ45 inputs or outputs, preventing RFI and EMI noise from entering the active circuit. Noise-Stopper Caps also protect against dust and corrosion.

Set of 4
Euro Retail: 34,95



USB-A Noise-Stopper Caps
 AQ Noise-Stopper Caps fit over unused USB inputs or outputs, preventing RFI and EMI noise from entering the active circuit. Noise-Stopper Caps also protect against dust and corrosion.

Set of 4
Euro Retail: 34,95



HDMI Noise-Stopper Caps
 AQ Noise-Stopper Caps fit over unused HDMI inputs or outputs, preventing RFI and EMI noise from entering the active circuit. Noise-Stopper Caps also protect against dust and corrosion.

Set of 4
Euro Retail: 34,95

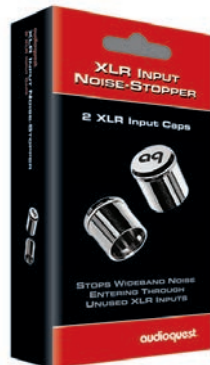

XLR Input (Female) Noise-Stopper Caps
 Blocks a significant path for incoming high-frequency energy to interfere with circuit performance.

Euro Retail
per Pair: 44,95

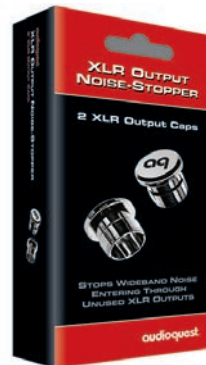

XLR Output (Male) Noise-Stopper Caps
 Blocks a significant path for incoming high-frequency energy to interfere with circuit performance.

Euro Retail
per Pair: 44,95

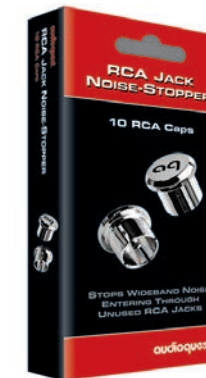







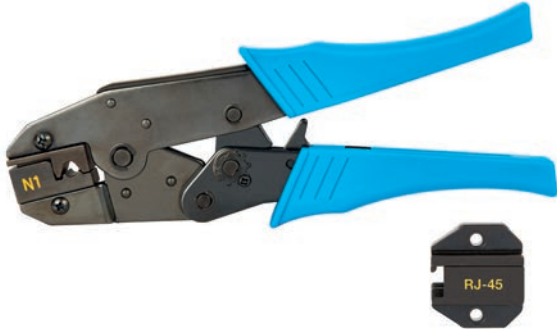

RCA Noise-Stopper Caps
 Blocks a significant path for incoming high-frequency energy to interfere with circuit performance.

Set of 10
Euro Retail: 54,95

Tools

All the Tools necessary to Cut, Strip, Prepare, and Terminate any AudioQuest Cable

| | | | |
|---|--|---|--|
|  | Cat6/6a/7 Crimper Tool and Die Includes Cat6 and Cat 7 Die |  | Rivers Interconnect Crimper Tool Use with either AudioQuest Chicago RCA, Red River and Mackenzie RCA or XLR plugs. |
|  | Cat6 Die Also sold separately | | |
|  | AQ Ratchet Crimper Tool For up to 8 AWG Conductors |  | Klein Crimper Tool For connectors up to 10 AWG |

| | |
|---|---|
|  |  |
| Klein Cable Cutter | Wire Stripper/Cutter/Plier Combo Tool |
|  |  |
| Ideal Articulated Stripper For 8–22 AWG Conductors | Paladin Jacket Stripper Cleanly and easily removes the jacket on all AudioQuest Interconnect and Speaker Cables |

| | |
|--|--|
|  | AQ Silver Solder Easy to use. Clearly sounds better. |
| | 454g Solder Euro Retail: 350,00 |
| | 113.5g Solder Euro Retail: 100,00 |

Instant Tool-less Connectors (ITC) for Analog-Audio, Mini-Coax, and RG6 Cables on Spools

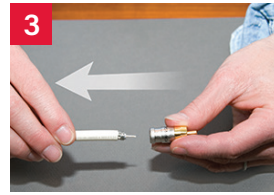
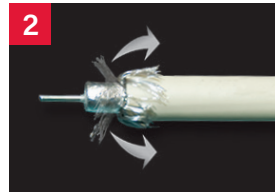

ITC One-Step Stripper for 18 and 24 AWG

For HD6, ITA, and ITV Cables

Euro Retail: 10,00

18 AWG Connectors and Cables for Video, RF, Digital, Subwoofer



ITC-18G
RCA
Euro Retail
per piece:
3,75

Supplied in
bags of 50



ITC-18G
F
Euro Retail
per piece:
3,00

Supplied in
bags of 50



ITC-18G
BNC
Euro Retail
per piece:
5,50

Supplied in
bags of 50



ITC-18G
EU Coax M
Euro Retail
per piece:
3,50

Supplied in
bags of 50



ITC-18G
EU Coax F
Euro Retail
per piece:
3,50

Supplied in
bags of 50

| | HD6 Pearl | HD6 Forest | HD6 Carbon |
|---------------------------------|---|------------------------------|--|
| Metal | Solid Conductive-Coated Copper | Solid 0,5% Silver | Solid 5% Silver |
| Shield | 3-Layer Shield: Foil + 90% Braid + Foil | | 4-Layer Shield: Carbon-Loaded PE + Foil + 90% Braid + Foil |
| CL3 Jacket Color Choices | Dark Gray or White Stripes | Gray, Green or White Stripes | Black, Gray, or White Stripes |
| Length | Euro Retail | Euro Retail | Euro Retail |
| 76m Spool | - | - | 20,00/m |
| 152m Spool | 6,50/m | 10,00/m | - |

24 AWG Connectors and Cables for Analog-Audio and Video



ITC-24G
RCA
Euro Retail
per piece:
3,75

Supplied in
bags of 50



ITC-24G
F
Euro Retail
per piece:
3,75

Supplied in
bags of 50



ITC-24G
BNC
Euro Retail
per piece:
5,50

Supplied in
bags of 50

| | ITA-1/1 | ITA-3/3 | ITA-5/5 |
|-------------------------------|-------------------------------|------------------------------------|--------------------------------------|
| Audio | | | |
| Center Conductor Metal | Solid Long-Grain Copper (LGC) | Solid Perfect-Surface Copper (PSC) | Solid Perfect-Surface Copper+ (PSC+) |
| Neg. Conductor/Shield | LGC HyperLitz | PSC HyperLitz | PSC+ HyperLitz |
| CL3 Jacket | Blue (Pair) | Green (Pair) | Dark Gray (Pair) |
| Length | Euro Retail | Euro Retail | Euro Retail |
| 15m Spool | 12,50/m | - | - |
| 76m Spool | 12,50/m | 20,00/m | 30,00/m |
| 152m Spool | 12,50/m | - | - |

Color Bands for 18 and 24 AWG ITC Connectors

Silicon rubber bands fit all ITC connectors—even after they're attached to the cable—for easy cable identification. Available in bags of 20. One color per bag – no mixed colors. Available in 10 colors.

Bag of 20
Euro Retail:
17,50



CL3/FT4 In-Wall Rated Bulk Speaker Cables

16/2 + 14/2 16/4 + 14/4



| Model | SLiP-DB 16/2 | SLiP-DB 16/4 | SLiP-DB 14/2 | SLiP-DB 14/4 | SLiP XTRM 14/2 | SLiP XTRM 14/4 | SLiP-LSZH 16/2 | SLiP-LSZH 14/2 |
|---------------|--|--------------------|---------------------|--------------------|--|---------------------|--|--------------------|
| Metal | Semi-Solid Concentric LGC | | | | Semi-Solid True Concentric PSC and LGC | | Semi-Solid Concentric LGC | |
| Gauge | 1,31mm ² | | 2,08mm ² | | | 1,31mm ² | 2,08mm ² | |
| Jacket | White PVC with Silver Stripes or Gray PVC with Red Stripes | | | | Dark Gray PVC with Blue Stripes | | LSZH (Low Smoke Zero Halogen) White PVC with Silver Stripes | |
| Length | Euro Retail | Euro Retail | Euro Retail | Euro Retail | Euro Retail | Euro Retail | Euro Retail | Euro Retail |
| 50m Spool | - | - | - | - | 30,00/m | - | - | - |
| 100m Spool | - | - | - | - | 30,00/m | 55,00/m | - | - |
| 152m Spool | 6,50/m | 10,00/m | 9,00/m | 14,00/m | - | - | 9,75/m | 12,50/m |



| Model | Type 5 | Rocket 11 | Rocket 22 | Rocket 33 | Rocket 44 | Rocket 88 |
|------------------------------|---|---------------------------|-----------------------------------|---|--|------------------------------|
| Metal | Solid PSC+ Sonic-Signature Conductors and LGC | Semi-Solid Concentric LGC | Semi-Solid Concentric PSC and LGC | Solid PSC and LGC | Solid PSC+ and PSC | Solid PSC+ |
| Gauge | 1,65mm ² | 2,62mm ² | 3,31mm ² | 2,62mm ² | 2,62mm ² | |
| Geometry | Star-Quad | Double-Spiral | | Double Star-Quad | | |
| Dielectric | N/A | PVC | | Foamed-Polyethylene (For All Positive Conductors) | | |
| Noise-Dissipation | Carbon-Based Noise-Dissipation | No | | Carbon-Based Noise-Dissipation | | |
| Jacket | Red Striped PVC | Black or White PVC | Black or White PVC | Black PVC with Red Stripes | Black PVC with Gloss Black Matte Stripes | Black PVC with Green Stripes |
| Single BiWire Capable | N/A | Yes | | | | |
| Length | Euro Retail | Euro Retail | Euro Retail | Euro Retail | Euro Retail | Euro Retail |
| 50m Spool | - | 20,00/m | 50,00/m | 70,00/m | 100,00/m | 130,00/m |
| 100m Spool | 30,00/m | 20,00/m | 50,00/m | 70,00/m | - | - |

Termination "Pants" available for Type 5, Rocket 11/22/33/44/88, page 55.

Bulk Speaker Cables — Not In-Wall Rated

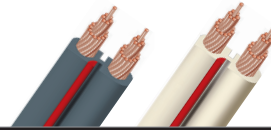
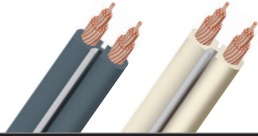

| Model | G2 | X2 | Q2 |
|------------------------------|---|--------------------------------|------------------------|
| Metal | Semi-Solid Concentric Long-Grain Copper (LGC) | | |
| Gauge | 1,31mm ² | 2,08mm ² | 1,65mm ² |
| Jacket | Dark Gray PVC or Off-White PVC | Dark Gray PVC or Off-White PVC | Black PVC or White PVC |
| Length | Euro Retail | Euro Retail | Euro Retail |
| 10m - <i>White Only</i> | 70,00 | - | - |
| 30m Pack - <i>White Only</i> | 210,00 | 250,00 | - |
| 100m spool | 7,00/m | 10,00/m | 16,50/m |

Note: For 100m spools, retail price per meter is listed. Other packaged lengths are shown with retail price per pack.



| Model | Rocket 33 | Rocket 44 | Rocket 88 |
|------------------------------|--|---|--------------------------------------|
| Metal | Solid Perfect-Surface Copper (PSC) and Long-Grain Copper (LGC) | Solid Perfect-Surface Copper+ (PSC+) and Perfect-Surface Copper (PSC) | Solid Perfect-Surface Copper+ (PSC+) |
| Gauge | 2,62mm ² | 2,62mm ² | |
| Geometry | Double Star-Quad | | |
| Dielectric | Foamed-Polyethylene (For All Positive Conductors) | | |
| Noise-Dissipation | Carbon-Based Noise-Dissipation | | |
| Jacket | Red/Black Braid | Silver/Black Braid | Green/Black Braid |
| Single BiWire Capable | Yes | | |
| Length | Euro Retail | Euro Retail | Euro Retail |
| 50m Spool | 70,00/m | 100,00/m | 130,00/m |
| 100m Spool | 70.00/m | - | - |

Termination "Pants" available for Type 5, Rocket 33/44/88, page 55.

SureGrip® Speaker Connectors

Fits up to 6,63mm² Speaker Cables



SureGrip® 100 Banana
Direct-Silver or Gold over Beryllium-Copper

SureGrip® 100 Multi-Spade
Direct-Silver or Gold Plating over Purple Copper

Allen Tool Included

Set of 8
Euro Retail: 60,00

Set of 12
Euro Retail: 90,00

Bag of 80
Euro Retail: 600,00

Bag of 120
Euro Retail: 900,00



SureGrip® 300 Banana
Direct-Silver or Gold over Beryllium-Copper

SureGrip® 300 Multi-Spade
Direct-Silver or Gold Plating over Purple Copper

Allen Tool Included

Set of 4
Euro Retail: 60,00

Tray of 40
Euro Retail: 600,00

Set of 4
Euro Retail: 60,00

Tray of 40
Euro Retail: 600,00

Black Labels Included



500 Series Banana or Multi-Spade
Hanging-Silver directly over pure Purple Copper or Hanging-Gold directly over pure Purple Copper. Silver or Gold.

507 - Sized for 10,55 mm² (same as original 500 connector)
509 - Sized for 6,63 mm²

Combination Allen and Phillips Tool Included

Set of 4
Euro Retail: 129,00

Set of 6
Euro Retail: 195,00



1000 Series Banana or Multi-Spade
Hanging-Silver directly over pure Red Copper.

1003 - Sized for 26,65 mm²
1005 - Sized for 16,76 mm²
1007 - Sized for 10,55 mm² (same as original 1000 connector)
1009 - Sized for 6,63 mm²









Combination Allen and Phillips Tool Included

Set of 4
Euro Retail: 219,00

Set of 6
Euro Retail: 329,00

Spade, Pin, and Banana Connectors

Supplied with Red and Black "Boots" (except 1002)

| | | |
|--|---|--|
|  <p>1410/S 1410/G Direct-Silver Plated and Direct-Gold Plated Up to 2,08 mm² 4,76mm Binding Post</p> <p>Set of 4 Euro Retail: 60,00</p> |  <p>1010/S 1010/G Direct-Silver Plated and Direct-Gold Plated Up to 5,26 mm² 4,76mm Binding Post</p> <p>Set of 4 Euro Retail: 80,00</p> |  <p>1414/S 1414/G Direct-Silver Plated and Direct-Gold Plated Up to 2,08 mm² 6,35mm Binding Post</p> <p>Set of 4 Euro Retail: 60,00</p> |
|  <p>1014/S 1014/G Direct-Silver Plated and Direct-Gold Plated Up to 5,26 mm² 6,35mm Binding Post</p> <p>Set of 4 Euro Retail: 60,00</p> |  <p>1056/S 1056/G Direct-Silver Plated and Direct-Gold Plated Up to 5,26 mm² 7,94mm Binding Post</p> <p>Set of 4 Euro Retail: 60,00</p> |  <p>P10M/S P10M/G Hanging-Silver and Hanging Gold Up to 5,26 mm² 6,35mm and 7,94mm Binding Post</p> <p>Set of 4 Euro Retail: 50,00</p> |
|  <p>BP10/S BP10/G Direct-Silver Plated and Direct-Gold Plated Up to 5,26 mm² Bendable Pin Fits Almost Everything</p> <p>Set of 4 Euro Retail: 40,00</p> |  <p>Crimp-BFA/S Crimp-BFA/G Direct-Silver Plated and Direct-Gold Plated Up to 6,63 mm² Standard Banana Jack</p> <p>Set of 4 Euro Retail: 40,00</p> |  <p>1002/S 1002/G Direct-Silver Plated and Direct-Gold Plated Up to 6,63 mm² Standard Banana Jack</p> <p>Set of 4 Euro Retail: 100,00</p> |

Termination "Pants" for Speaker Cables



| | Full-Range | Single BiWire |
|-----------------------|-------------|---------------|
| Model | Euro Retail | Euro Retail |
| Rocket 11 Pants set/4 | 14,95 | 19,95 |
| Rocket 22 Pants set/4 | 14,95 | 19,95 |
| Rocket 33 Pants set/4 | 14,95 | 19,95 |
| Rocket 44 Pants set/4 | 14,95 | 19,95 |
| Rocket 88 Pants set/4 | 14,95 | 19,95 |
| Type 5 Pants set/4 | 14,95 | - |

CL3/FT4 In-Wall Rated Bulk Audio Interconnect Cables & Plugs

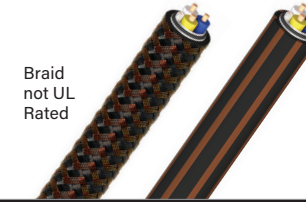
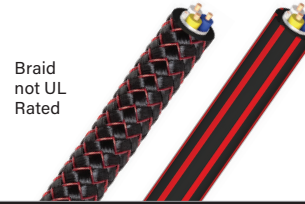
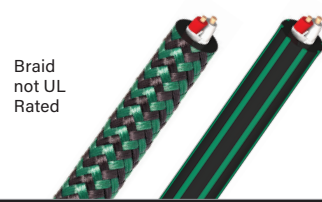

| Model | Chicago | Red River | Mackenzie |
|--------------------------|---|---|---|
| Metal | Solid Long-Grain Copper (LGC) | Solid Perfect-Surface Copper (PSC) | Solid Perfect-Surface Copper+ (PSC+) |
| Geometry | Double-Balanced | Triple-Balanced (Separate Ground-Reference Conductor) | |
| Dielectric | Hard-Cell Foam | | |
| Noise-Dissipation | Metal-Layer Noise-Dissipation | | Carbon-Based Multi-Layer Noise-Dissipation |
| Jacket | Green/Black Braid or CL3 Black PVC with Green Stripes | Red/Black Braid or CL3 Black PVC with Red Stripes | Brown/Black Braid or CL3 Black PVC with Brown Stripes |
| Length | Euro Retail | Euro Retail | Euro Retail |
| 50m | - | - | 30,00m |
| 100m | 10,00/m | 20,00/m | - |

Note: For spools, retail price per meter is listed.

Field Termination Connectors

To download Chicago, Red River, and Mackenzie cable termination manuals, go to <https://www.audioquest.com/custom-install/manuals>



Rivers Interconnect Crimper Tool

Required with either AudioQuest Chicago RCA, Red River and Mackenzie RCA or XLR plugs.



Chicago RCA
Gold-Plated

Set of 4
Euro Retail: 89,00



Red River RCA
Gold-Plated

Set of 4
Euro Retail: 89,00



Red River XLR
Gold-Plated

Set of 4
Euro Retail: 169,00



Mackenzie RCA
Hanging-Silver over Purple Copper

Set of 4
Euro Retail: 109,00



Mackenzie XLR
Hanging-Silver over Purple Copper

Set of 4
Euro Retail: 199,00

CL3/FT4 In-Wall Rated Bulk CAT6 and CAT7 Ethernet Cables & Plugs

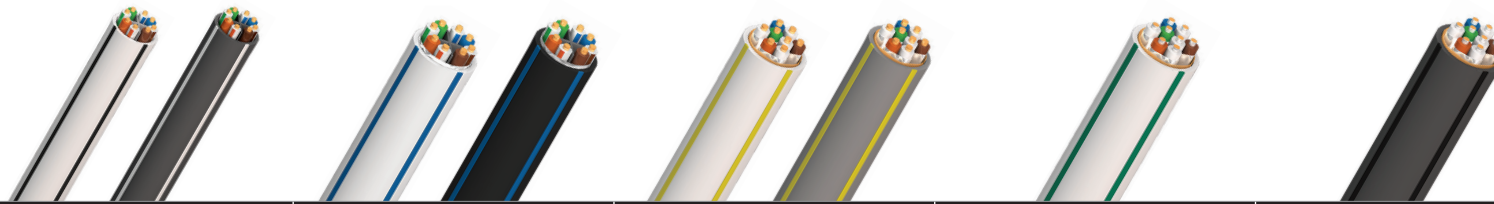

| | CAT 600 DCP | CAT 600 FMJ | CAT 700 Pearl | CAT 700 Forest | CAT 700 Carbon |
|-------------------|--|--|--|--|--|
| Metal | Solid Long-Grain Copper (LGC) | | | Solid 0,5% Silver | Solid 5% Silver |
| Shield | N/A | Overall Shield | Overall Shield and Individual Pairs | | |
| Gauge | 23 AWG | | | | |
| Dielectric | Solid High-Density Polyethylene | | | Hard-Cell Foam | |
| Jacket | CMG (CL3/FT4) Rated White PVC with Black Stripes or Dark Gray PVC with White Stripes | CMG (CL3/FT4) Rated White or Black PVC with Blue Stripes | CMG (CL3/FT4) Rated White or Medium Gray PVC with Yellow PVC | CMG (CL3/FT4) Rated White PVC with Green Stripes | CMG (CL3/FT4) Rated Dark Gray PVC with Black Stripes |
| Length | Euro Retail | Euro Retail | Euro Retail | Euro Retail | Euro Retail |
| 152m | - | 5,00/m | 10,00/m | 15,00/m | 65,00/m |
| 305m | 3,75/m | - | - | - | - |

Note: For spools, retail price per meter is listed.

CAT6/7 Connectors

To download CAT600 and CAT700 cable termination manuals, go to <https://www.audioquest.com/custom-install/manuals>



Cat6/6a/7 Crimper Tool and Die

Required to terminate our Cat6/7 cables and connectors, includes Cat6 and Cat7 Die.



Cat6 Die

Also sold separately



Load Bar Connector Boot

CAT600 DCP Connectors

Fits **CAT600DCP** cable and **standard unshielded** Cat6 cables

Each Euro **Bag of 50**
Retail: 1,75 **Euro Retail: 87,50**



Load Bar Connector Boot

CAT600 FMJ Connectors

Fits **CAT600FMJ**, **CAT700** and **standard shielded Cat6/Cat7** cables

Each Euro **Bag of 50**
Retail: 3,75 **Euro Retail: 187,50**



Load Bar Connector Boot

CAT700 Connectors

Fits **CAT600FMJ**, **CAT700** and **standard shielded Cat6/Cat7** cables

Each Euro **Bag of 50**
Retail: 4,00 **Euro Retail: 200,00**



CAT700 Telegärtner Male Connector

Fits all standard Cat6a/Cat7 cables

Each
Euro Retail: 29,50

Installer Packs

Cables and Accessories in Installer-Friendly bags instead of hanging boxes.

Installer Packs provide exactly what you need to get the job done. Each Pack includes a number of high-value, high-performance AudioQuest pieces and comes with convenient integrated labels that you can peel off and place on your invoice. No retail packaging, no garbage in your truck, no excess waste or cost.

Audio Interconnect Cables

Packs of 5



| | Tower | Golden Gate | Alpha-Snake |
|---------------|------------------------------|------------------------------|-----------------------------|
| Length | Euro Retail per Cable | Euro Retail per Cable | Euro Retail per Pair |
| 0,5m | - | - | 27,95 |
| 0,6m | 45,95 | 119,00 | - |
| 1m | 49,95 | 129,00 | 34,95 |
| 2m | 59,95 | 149,00 | 39,95 |
| 3m | 69,95 | 169,00 | 44,95 |

0,6m available in RCA - RCA only.

1 - 3m available in RCA - RCA, 3,5mm - RCA, 3,5mm - 3,5mm.

Optical Cables

Packs of 5



| | Pearl | Forest | Cinnamon |
|---------------|------------------------------|------------------------------|------------------------------|
| Length | Euro Retail per Cable | Euro Retail per Cable | Euro Retail per Cable |
| 0,75m | 34,95 | 54,95 | 79,00 |
| 1,5m | 39,95 | 64,95 | 99,00 |
| 3m | 59,95 | 99,95 | 149,00 |

Available in Full-to-Full configurations only.

Audio Interconnect FLX-X RCA Splitters

Packs of 5



| M22F | F22M |
|-------------------------|-------------------------|
| Euro Retail Each | Euro Retail Each |
| 24,95 | 24,95 |

AC Power C7 90° Adaptors

Packs of 10



| E = Equal radius | U = Unequal radius |
|-------------------------|-------------------------|
| Euro Retail Each | Euro Retail Each |
| 22,95 | 22,95 |

HDMI Cables

Packs of 5



| | BlueBerry | Pearl 48 | Forest 48 |
|---------------|------------------------------|------------------------------|------------------------------|
| | Euro Retail per Cable | Euro Retail per Cable | Euro Retail per Cable |
| Length | | | |
| 0,6m | 29,95 | 39,95 | 69,00 |
| 1m | 34,95 | 44,95 | 79,00 |
| 1,5m | 39,95 | 49,95 | 99,00 |
| 2m | 44,95 | 59,95 | 119,00 |
| 3m | 59,95 | 79,95 | 159,00 |
| 5m | 99,95 | 199,95 | 299,00 |

BlueBerry meets the 18G bandwidth required for video up to 8K/30;
 Pearl 48, Forest 48, and Cinnamon 48 extend this capability up to 8K/60 and 4K/120.

HDMI Adaptors

Packs of 5

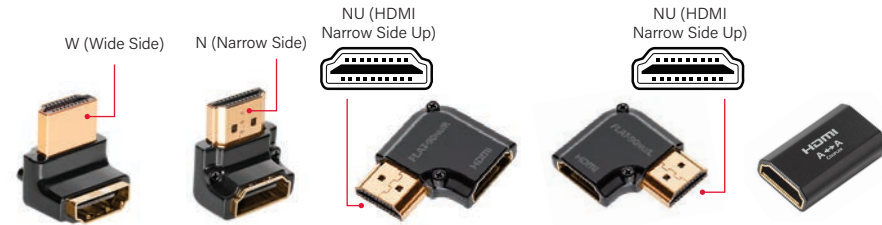

| HDMI 90° /W | HDMI 90° /N | HDMI 90° NU/R | HDMI 90° NU/L | HDMI Coupler |
|--------------------|--------------------|--------------------|--------------------|--------------------|
| Retail Each | Retail Each | Retail Each | Retail Each | Retail Each |
| 19,95 | 19,95 | 19,95 | 19,95 | 19,95 |

Ethernet Cables (RJ/E)

Packs of 5



| | Pearl | Forest | Cinnamon |
|---------------|------------------------------|------------------------------|------------------------------|
| | Euro Retail per Cable | Euro Retail per Cable | Euro Retail per Cable |
| Length | | | |
| 0,75m | 39,95 | 79,00 | 119,00 |
| 1,5m | 59,95 | 99,00 | 139,00 |
| 3m | 79,95 | 119,00 | 179,00 |
| 5m | 119,95 | 169,00 | 239,00 |

Digital Coax Cables

Packs of 5



| | Forest |
|---------------|------------------------------|
| | Euro Retail per Cable |
| Length | |
| 0,75m | 44,95 |
| 1,5m | 54,95 |
| 3m | 74,95 |
| 5m | 99,95 |

AudioQuest Branded Point of Purchase (POP) Materials



Slat Wall Sign



Acrylic Wall Sign - Red



Acrylic Wall Sign - Black



Tent Card



Window Sticker



Cube Spool Holder

Rugged metal spool holder comes with convenient merchandising labels and accommodates almost any AQ spool.



In-Store Display Rack

Spool holder sold separately.

Dimensions: 193cm (h) x 89cm (w) x 33cm (d)



Standalone Display Rack

AudioQuest Branded Promotional Items



Polo Shirt

Our versatile polo shirt looks great with anything. Classic black with a discreet silver AudioQuest logo.

Men's sizes: S-2XL; Women's sizes: S-XL.



T-Shirt

Our classic crewneck t-shirt is made from 100% lightweight, preshrunk cotton for a perfect fit that's as attractive as it is comfortable. Our t-shirt features a tasteful red AudioQuest logo against a solid black background.

Sizes: S-3XL



Chino Washed Cotton Baseball Cap

Our baseball cap has a durable 8-stitch bill for a long-lasting, contoured shape. The Velcro fastener provides easy adjustments for a perfect fit. Available in black with red AudioQuest logo and trim, this cap looks and feels great. One size fits all.



Beanie

Red, gray, and black, with our classic red AudioQuest logo, our stylish beanie is made from super-stretch, fine-gauge acrylic, for a warm, snug fit over your head and ears. The perfect accessory for those cooler days. One size fits all.



Pen

Take note: With its discreet AQ logo, piano-black lacquered tube, and chrome accents, this ballpoint pen has the looks to match the quality of your prose. Keep it in your AudioQuest backpack and take it with you wherever you go.



Water Bottle

Made by Specialized, this 769ml leak-proof water bottle has a self-sealing valve and features easy-to-squeeze BPA-free, recyclable plastic. Our distinct Wolves artwork is printed with a non-solvent based, CPSC-approved ink. Just aim and squeeze for clean, pure refreshment.

AudioQuest Branded Promotional Items



License Plate

It's all about the journey. Take your love for AudioQuest on the road with this license-plate frame. The clean, simple design features our red AudioQuest logo and "Experience the Difference" mantra set against a black background—perfect for any ride. Vroom!



Backpack

Available in black with our black AudioQuest and Four Elements logos. Accommodates laptops with 13" screens and tablets. Made of nylon.



Padded Backpack

Do no harm with our padded backpack. It features a discreet front-panel zipper, multiple internal pockets, and mesh side pockets for drinks and other items. A padded laptop insert safely accommodates screens up to 15". Mesh backing and straps are durable and comfortable, making the backpack as easy to carry as it is to wear.



Tote Bag

This super-durable tote bag is made of water-repellent polyester and has a long strap that fits easily over a shoulder. Measuring 38cm x 36.5cm, its slim pocket is perfect for carrying AudioQuest merchandise—pens, tumblers, price books—and even an LP or two! The simple black-on-black design features a subtly stylish AQ logo.

Index

A

AC Power Cables

| | |
|----------------------------------|----|
| Mistral AC Power Bulk Cable..... | 10 |
| NRG-X2 | 9 |
| See also Installer Packs, pg. 58 | |
| NRG-Y2 | 9 |
| See also Installer Packs, pg. 58 | |
| NRG-Z2 | 9 |
| See also Installer Packs, pg. 58 | |
| NRG-X3 | 9 |
| See also Installer Packs, pg. 58 | |
| NRG-Y3 | 9 |
| See also Installer Packs, pg. 58 | |
| NRG-Z3 | 9 |
| See also Installer Packs, pg. 58 | |
| Monsoon | 10 |
| Monsoon XTRM..... | 10 |
| Blizzard | 10 |
| Blizzard XTRM | 10 |
| Silver Cloud | 10 |
| Silver Cloud XTRM | 10 |
| Thunder (High-Current) | 11 |
| Tornado (High-Current)..... | 11 |
| Tornado (Source)..... | 11 |
| Hurricane (High-Current)..... | 11 |
| Hurricane (Source)..... | 11 |
| FireBird (High-Current)..... | 11 |
| FireBird (Source)..... | 11 |
| Dragon (High-Current) | 11 |
| Dragon (Source)..... | 11 |

AC Power Conditioners

| | |
|--------------------|---|
| PowerQuest G8..... | 7 |
| PowerQuest 2..... | 7 |
| PowerQuest 3..... | 7 |
| Niagara 1200..... | 7 |
| Niagara 3000..... | 7 |
| Niagara 5000..... | 7 |
| Niagara 7000..... | 7 |

Adaptors

| | |
|--|----|
| C7 90° Adaptor Kit | 12 |
| See also Installer Packs, pg. 58 | |
| DragonTail A to C Adaptor | 5 |
| DragonTail USB A 2.0 Extender..... | 5 |
| DragonTail USB A to Micro Adaptor..... | 5 |
| DVI-IN to HDMI-OUT Adaptor..... | 38 |
| F-90° Adaptor | 47 |
| FLX-Mini/RCA Adaptor..... | 28 |
| F to BNC Male Adaptor..... | 47 |
| F to RCA Male Adaptor..... | 47 |
| Hard Mini/RCA Adaptor | 28 |

| | |
|--|----|
| HDMI 90°/W Adaptor | 38 |
| See also Installer Packs, pg. 59 | |
| HDMI 90°/N Adaptor..... | 38 |
| See also Installer Packs, pg. 59 | |
| HDMI 90° NU/L Flat Adaptor..... | 38 |
| See also Installer Packs, pg. 59 | |
| HDMI 90° NU/R Flat Adaptor | 38 |
| See also Installer Packs, pg. 59 | |
| IEC>3US Power Strip..... | 12 |
| IEC90/1..... | 12 |
| IEC90/2..... | 12 |
| M21F-90 Adaptor..... | 28 |
| Mini Display Port to HDMI 4K Adaptor..... | 38 |
| Optical Mini Adaptor..... | 42 |
| RCA - BNC Adaptor | 47 |
| RCA to BNC | 43 |
| USB 3.1 C to A Adaptor | 41 |
| USB B - Micro B 2.0 Adaptor..... | 41 |
| USB Mini B - Micro B 2.0 Adaptor | 41 |

AES/EBU (Balanced) Cables

| | |
|--------------------|----|
| Carbon | 44 |
| Diamond | 44 |
| Wild..... | 44 |
| WEL Signature..... | 44 |

Audio Interconnect Cables

| | |
|-----------------------------------|----|
| Tower | 25 |
| See also Installer Packs, pg. 58 | |
| Evergreen | 25 |
| Golden Gate..... | 25 |
| See also Installer Packs, pg. 58 | |
| Big Sur..... | 25 |
| Sydney..... | 25 |
| Yosemite | 25 |
| Angel | 25 |
| Chicago..... | 26 |
| See also Bulk Cables, pg. 58 | |
| Red River..... | 26 |
| See also Bulk Cables, pg. 58 | |
| Mackenzie..... | 26 |
| See also Bulk Cables, pg. 58 | |
| Yukon | 26 |
| Black Beauty | 26 |
| Pegasus..... | 26 |
| ThunderBird | 27 |
| FireBird | 27 |
| Dragon..... | 27 |
| Alpha-Snake, Installer Packs..... | 58 |

B

BiWire Jumpers

| | |
|---------------------------------|----|
| Bare Naked BiWire Jumpers | 23 |
| ThunderBird | 23 |
| Dragon..... | 23 |

Bulk Cables

| | |
|---------------------|----|
| HD6 Pearl | 51 |
| HD6 Forest | 51 |
| HD6 Carbon | 51 |
| ITA-1/1..... | 51 |
| ITA-3/3..... | 51 |
| ITA-5/5..... | 51 |
| SLiP/DB-16/2 | 52 |
| SLiP/DB-16/4 | 52 |
| SLiP/DB-14/2 | 52 |
| SLiP/DB-14/4 | 52 |
| SLiP XTRM 14/2..... | 52 |
| SLiP XTRM 14/4..... | 52 |
| G2 | 53 |
| X2 | 53 |
| Q2 | 53 |
| Type 5..... | 52 |
| Rocket 11 | 52 |
| Rocket 22..... | 52 |
| Rocket 33..... | 53 |
| Rocket 44 | 53 |
| Rocket 88..... | 53 |
| Chicago | 56 |
| Mackenzie..... | 56 |
| Red River..... | 56 |
| CAT600 DCP | 57 |
| CAT600 FMJ..... | 57 |
| CAT700 Pearl..... | 57 |
| CAT700 Forest..... | 57 |
| CAT700 Carbon..... | 57 |

C

Cable Clips..... 46

Cable Risers

| | |
|------------------|------------|
| Fog Lifters..... | 12, 23, 46 |
|------------------|------------|

Cleaner

| | |
|----------------------|----|
| CleanScreen Kit..... | 46 |
|----------------------|----|

Connectors

| | |
|-----------------------------|----|
| 507 Series Banana | 54 |
| 1000 Series Banana | 54 |
| Banana Connectors..... | 55 |
| CAT600 DCP Connectors..... | 57 |
| CAT600 FMJ Connectors | 57 |
| CAT700 Connectors..... | 57 |

| | |
|--|----|
| CAT700 Telegärtner Male Connector | 57 |
| Chicago RCA | 56 |
| Color Bands for 18 and 24 AWG ITC Connectors..... | 51 |
| F-90°..... | 48 |
| ITC-18G/BNC..... | 51 |
| ITC-18G/F | 51 |
| ITC-18G/RCA..... | 51 |
| ITC-24G/BNC..... | 51 |
| ITC-24G/F..... | 51 |
| ITC-24G/RCA..... | 51 |
| Mackenzie RCA..... | 56 |
| Mackenzie XLR | 56 |
| Pin Connectors | 55 |
| RCA-90°..... | 48 |
| RCA-300 | 48 |
| RCA-800 | 48 |
| Red River RCA..... | 56 |
| Red River XLR | 56 |
| Spade Connectors | 55 |
| SureGrip 100 Banana..... | 54 |
| SureGrip 100 Multi-Spade | 54 |
| SureGrip 300 Banana | 54 |
| SureGrip 300 Multi-Spade..... | 54 |
| XLR Connectors..... | 48 |

Couplers

| | |
|----------------------------------|----|
| F - F Coupler..... | 47 |
| HDMI A - A Coupler..... | 38 |
| See also Installer Packs, pg. 59 | |
| RCA - RCA Coupler | 28 |

D

DBS Pack, Level-X..... 46

Digital Coax Cables

| | |
|----------------------------------|----|
| Forest | 43 |
| See also Installer Packs, pg. 59 | |
| Cinnamon | 43 |
| Carbon | 43 |
| Coffee..... | 43 |
| Diamond | 43 |
| Wild..... | 43 |
| WEL Signature..... | 43 |

DragonFly

| | |
|-------------|---|
| Black..... | 5 |
| Red | 5 |
| Cobalt..... | 5 |

Index

E

Ethernet Cables (RJ/E)

| | |
|----------------------------------|----|
| Pearl | 45 |
| See also Installer Packs, pg. 59 | |
| Forest | 45 |
| See also Installer Packs, pg. 59 | |
| Cinnamon | 45 |
| See also Installer Packs, pg. 59 | |
| Vodka | 45 |
| Diamond | 45 |

F

Fog Lifters 12, 23, 46

G

GroundGoody

| | |
|-------------|----|
| ThunderBird | 33 |
| Dragon | 33 |

H

HDMI Cables

| | |
|----------------------------------|----|
| BlueBerry | 36 |
| See also Installer Packs, pg. 59 | |
| Pearl 48 | 36 |
| See also Installer Packs, pg. 59 | |
| Forest 48 | 36 |
| See also Installer Packs, pg. 59 | |
| Cinnamon 48 | 36 |
| Carbon 48 | 36 |
| Vodka 48 | 36 |
| ThunderBird 48 | 36 |
| FireBird 48 | 36 |
| Dragon 48 | 36 |
| Pearl 18 Long Distance | 37 |
| Forest 18 Long Distance | 37 |
| Root Beer 18 Optical | 37 |
| Cherry Cola 48 Optical | 37 |
| Vodka eARC | 37 |
| ThunderBird eARC | 37 |
| Dragon eARC | 37 |

Headphone Accessories

| | |
|---------------------------|----|
| Headphone Plug Adaptor | 33 |
| HL-5 Headshell Leads | 33 |
| NightBird Headphone Cable | 33 |
| Perch Headphone Stand | 33 |

J

JitterBug FMJ 5

See also USB Accessories, pg. 41

N

Noise-Stopper Caps

| | |
|--|----|
| HDMI Noise-Stopper Caps | 49 |
| RCA Noise-Stopper Caps | 49 |
| RJ45 Noise-Stopper Caps | 49 |
| USB-A Noise-Stopper Caps | 49 |
| XLR Input (Female) Noise-Stopper Caps | 49 |
| XLR Output (Male) Noise-Stopper Caps | 49 |

O

Optical Cables

| | |
|----------|----|
| Pearl | 42 |
| Forest | 42 |
| Cinnamon | 42 |
| Carbon | 42 |
| Vodka | 42 |

P

POP Materials

| | |
|--------------------------------|----|
| Acrylic Wall Sign - Black, Red | 60 |
| Cube Spool Holder | 60 |
| Display Rack, In-Store | 60 |
| Display Rack, Standalone | 60 |
| Slat Wall Sign | 60 |
| Tent Card | 60 |
| Window Sticker | 60 |

PreAmp Jumpers 28

Promotional Items

| | |
|------------------|----|
| Backpack | 62 |
| Backpack, Padded | 62 |
| Baseball Cap | 61 |
| Beanie | 61 |
| Hooded Jacket | 61 |
| License Plate | 62 |
| Pen | 61 |
| Polo Shirt | 61 |
| Tote Bag | 62 |
| T-Shirt | 61 |
| Tumbler | 61 |
| Water Bottle | 61 |

Q

Q-Feet, SorboGel 46

R

Record Brushes

| | |
|----------------------------------|----|
| Classic Anti-Static Record Brush | 33 |
| Super-Conductive Record Brush | 33 |

S

Solder, Silver 50

Sorbothane Self-Stick Sheet 46

Speaker Cables

| | |
|-----------------------------------|----|
| Q2 | 16 |
| See also Bulk Cables, pg. 53 | |
| Type 5 | 16 |
| See also Bulk Cables, pg. 52 | |
| Type 9 | 16 |
| Type 9+DBS | 16 |
| Rocket 11 | 17 |
| See also Bulk Cables, pg. 52 | |
| Rocket 22 | 17 |
| See also Bulk Cables, pg. 52 | |
| Rocket 33 | 17 |
| See also Bulk Cables, pgs. 52, 53 | |
| Rocket 44 | 17 |
| See also Bulk Cables, pgs. 52, 53 | |
| Rocket 88 | 17 |
| See also Bulk Cables, pgs. 52, 53 | |
| Robin Hood ZERO | 18 |
| Robin Hood BASS | 18 |
| Robin Hood ZERO BiWire COMBO | 1 |
| Robin Hood SILVER | 18 |
| Robin Hood SILVER BiWire COMBO | 18 |
| William Tell ZERO | 19 |
| William Tell BASS | 19 |
| William Tell ZERO BiWire COMBO | 19 |
| William Tell SILVER | 19 |
| William Tell SILVER BiWire COMBO | 19 |
| ThunderBird ZERO | 20 |
| ThunderBird BASS | 20 |
| ThunderBird ZERO BiWire COMBO | 20 |
| FireBird ZERO | 21 |
| FireBird BASS | 21 |
| FireBird BiWire COMBO | 21 |
| Dragon ZERO | 22 |
| Dragon BASS | 22 |
| Dragon BiWire COMBO | 22 |

Splitters

| | |
|----------------------------------|----|
| FLX-Mini Splitter | 28 |
| FLX-X RCA Splitter | 28 |
| See also Installer Packs, pg. 58 | |
| F to 2F Splitter | 47 |
| F to 4F Splitter | 47 |
| Hard RCA Splitter | 28 |

Subwoofer Cables

| | |
|-----------|----|
| Black Lab | 29 |
| Greyhound | 29 |
| Irish Red | 29 |
| Boxer | 29 |
| Husky | 29 |

T

Termination Pants

| | |
|-----------|----|
| Rocket 11 | 55 |
| Rocket 22 | 55 |
| Rocket 33 | 55 |
| Rocket 44 | 55 |
| Rocket 88 | 55 |
| Type 5 | 55 |
| Type 9 | 55 |

Tonearm Cables

| | |
|-------------------------------|----|
| Golden Gate | 31 |
| Yosemite | 31 |
| Angel | 31 |
| WEL Signature Limited Edition | 31 |

Tools

| | |
|--|--------|
| AQ Ratchet Crimper Tool | 50 |
| Binding-Post Wrench | 47 |
| Cat6/6a/7 Crimper Tool and Die | 50, 57 |
| Cat6 Die | 50, 57 |
| Ideal Articulated Stripper | 50 |
| ITC One-Step Stripper for 18 and 24 AWG | 51 |
| Klein Cable Cutter | 50 |
| Klein Crimper Tool | 50 |
| Paladin Jacket Stripper | 50 |
| Rivers Interconnect Crimper Tool | 50, 56 |
| Wire Stripper/Cutter/Plier Combo Tool | 50 |

Turntable Cables

| | |
|-------------|----|
| Golden Gate | 31 |
| Yosemite | 31 |
| Angel | 31 |

U

USB Cables

| | |
|----------|----|
| Pearl | 40 |
| Forest | 40 |
| Cinnamon | 40 |
| Carbon | 40 |
| Coffee | 40 |
| Diamond | 40 |

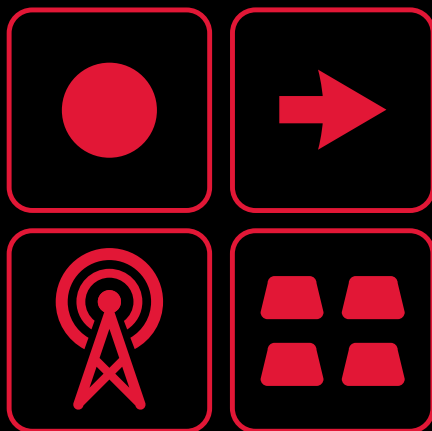

audioquest[®]

www.audioquest.com

Tel +31 165 54 1404